BERTAZZONI PROFESSIONAL SERIES

30" DROP-IN LOW EDGE COOKTOP 4 BURNER Q30 4 00 X



Bertazzoni drop-in gas cooktops bring professional performance and surface cooking convenience together in an elegant solution. Available in a 30-inch size, this Bertazzoni cooktop features the same one-piece seamless worktop design that has become the signature of Bertazzoni freestanding ranges. The model is available with high efficiency burners for enhanced performance and a dual zone power burner delivering best-in-class heat up times adding maximum flexibility thanks to its wide BTU range.

POWER BURNER



Bertazzoni's exclusive dual zone power burner delivers high-efficiency performance from a delicate low simmer to full power (750 - 18,000 BTUs) with best-in-class heat-up time.



TO COOK BEAUTIFULLY

BERTAZZONI PROFESSIONAL SERIES

30" DROP-IN LOW EDGE COOKTOP 4 BURNER Q30 4 00 X

FEATURES

Aluminum burners	4
Dual wok (1x)	750-18000 Btu/h
Rapid (1x)	11000 Btu/h
Semi-rapid (1x)	6500 Btu/h
Auxiliary (1x)	3400 Btu/h
Simmer rate	750 Btu/h
Maintop	stainless steel
Worktop controls	knobs
Knobs	soft touch
Grates	cast iron
One hand ignition	yes
Wok adapter	yes
Simmer ring	yes

TECHNICAL SPECIFICATIONS

Electrical Requirements	120 V 60 Hz
Max Amp usage, power rating	1 A - 1 W
Certification	CSA
Warranty	2 years parts and labor

ACCESSORIES

Simmer ring (standard)	code 408077
Wok ring (standard)	code 408117

A LP conversion kit for all burners is included

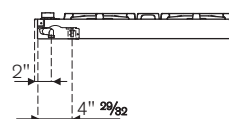
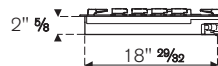
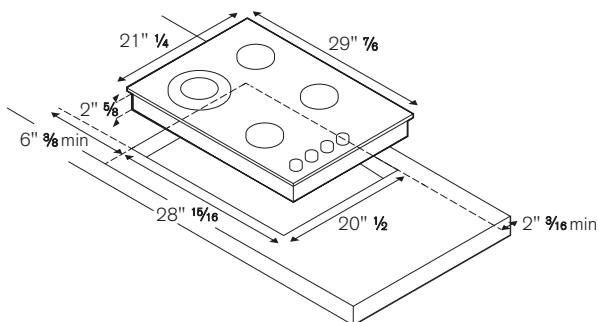

INSTALLATION INSTRUCTIONS

Bertazzoni recommends to operate the appliance after it has been installed in a cabinet.

The kitchen cabinets shall be made of materials capable of withstanding temperatures at least 117°F (65°C) above room temperature in order to avoid possible damage to the cabinets during appliance usage.

Disclaimer: while every effort has been made to insure the accuracy of the information contained in this brochure, Fratelli Bertazzoni reserves the right to change any part of the information at any time without notice.

Fratelli Bertazzoni, Bertazzoni and the winged wheel brand icon are registered trademarks of Bertazzoni Spa.