

---

# BERTAZZONI PROFESSIONAL SERIES

## 30" UNDERMOUNT CANOPY HOOD KU30 PRO 1 X



The single-motor canopy hoods deliver extraction power up to 600 CFM with three different power settings. They come equipped with aluminum mesh filters or optional baffle filters, all easily removable and dishwasher safe. They can be installed under a cabinet or on the wall with an optional narrow or full-width duct cover. The design matches Bertazzoni Professional Series ranges and cooktops while also complementing other Bertazzoni Series.

### SINGLE MOTOR CANOPY



Single motor canopy hood shown with optional narrow duct cover. Full-width duct cover is also available.



TO COOK BEAUTIFULLY

# BERTAZZONI PROFESSIONAL SERIES

## 30" UNDERMOUNT CANOPY HOOD KU30 PRO 1 X

### FEATURES

Hood finishing	stainless steel
Motor	1
Speed	3
Hood control	electronic with buttons
Halogen lights	2
Filters	aluminum mesh
Max extraction power	600 cfm

### TECHNICAL SPECIFICATIONS

Electrical Requirements	120 V 60 Hz
Max Amp usage, power rating	3.3 A - 400 W
Certification	cETLus
Warranty	2 years parts and labor

### ACCESSORIES

Recirculation Kit	code 901154
Narrow duct cover	code 901262
Full-width duct cover	code 901266
Narrow duct cover for ceiling height 8-10 ft	code 901281
European Baffle Filter	code 901253

This model is not suited for recirculation

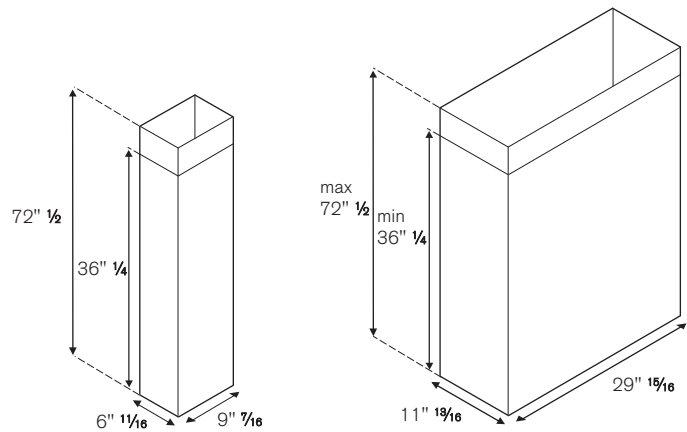
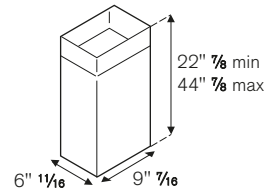
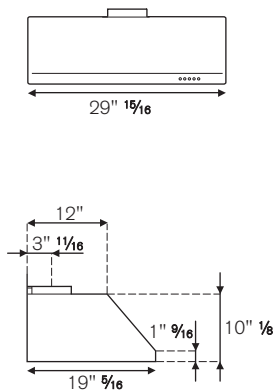
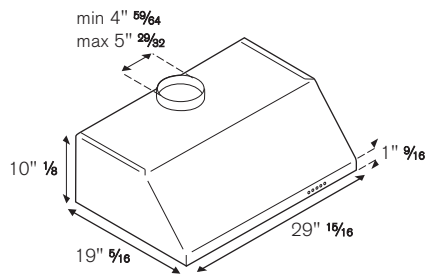

### INSTALLATION INSTRUCTIONS

Bertazzoni recommends to operate the appliance after it has been properly installed. Please refer to the installation manual for further details.

**Disclaimer:** while every effort has been made to insure the accuracy of the information contained in this brochure, Fratelli Bertazzoni reserves the right to change any part of the information at any time without notice.

Fratelli Bertazzoni, Bertazzoni and the winged wheel brand icon are registered trademarks of Bertazzoni Spa.