

SIGNATURE SERIES SOTTILE REFRIGERATOR

HH24RS-3 | 24" INDOOR MODEL
HH24RO-3 | 24" OUTDOOR MODEL

Perlick[®]
QUALITY & INNOVATION
THAT **INSPIRES**



Solid Door Model



Glass Door Model



GENERAL SIGNATURE SERIES SOTTILE FEATURES

- 32" height including leveling legs
- **Industry Exclusive** 18" depth for design flexibility
- Plug recessed for true 18" depth
- Zero-clearance hinging allows for abutment with surrounding cabinetry
- 525 Btu commercial-grade compressor
- Front-vented, RAPIDcool forced-air refrigeration system
- Commercial-grade stainless steel interior and exterior
- **Industry Exclusive** convertible door design allows all doors the ability to be converted to wood overlay from stainless steel
- **Industry Exclusive** adjustable, full-extension pull-out shelves
- Stainless-steel ball-bearing glides provide smooth movement of shelves
- Low E, UV-coated glass provides industry leading insulation and protection.
- Digital temperature controller
- Adjustable Crisp White and Cool Blue LED lighting
- Stacking kit available
- Also available Signature Series Sottile Indoor Beverage Center and Wine Reserve and Outdoor Refrigerator, Beverage Center and Wine Reserve
- 3.1 cubic feet of capacity
- Industry Best Three Year Warranty plus additional three years on sealed system

HH24RS FEATURES

- Available with solid stainless steel door, solid wood overlay door, stainless steel glass door or wood overlay glass doors
- Includes two (2) full-extension pull-out shelves
- Product capacity is 95 cans (12 oz.)
- Refrigerator temperature 33°- 42°F

Form No.HH24RS-3
Rev. 1.8.2015

PRODUCT SPECIFICATIONS

Overall Width	23-7/8" (60.64 cm.)
Overall Height	32" (81.28 cm.)
Overall Depth	18" (45.72 cm.)
Opening Width	24" (60.96 cm.)
Opening Height	32-1/8" (81.60 cm.)
Opening Depth	18" (45.72 cm.)
Refrigerated Volume	3.1 cu. ft.
Door Swing Clearance	25" (63.5 cm.) minimum
Electrical	115V, 60Hz, 1 Phase, 2.3 amps
Plumbing	None Required
Annual Energy Usage	283 kWh/yr
Shipping Weight	185 lbs (83.91 kg.)

INDOOR MODELS

HH24RS-3-1L*	Solid stainless steel door, hinge left
HH24RS-3-2L*	Solid wood overlay door, hinge left
HH24RS-3-3L*	Stainless steel glass door, hinge left
HH24RS-3-4L*	Wood overlay glass door, hinge left

OUTDOOR MODELS

HH24RO-3-1L*	Solid stainless steel door, hinge left
HH24RO-3-2L*	Solid wood overlay door, hinge left
HH24RO-3-3L*	Stainless steel glass door, hinge left
HH24RO-3-4L*	Wood overlay glass door, hinge left

* Also available hinge right

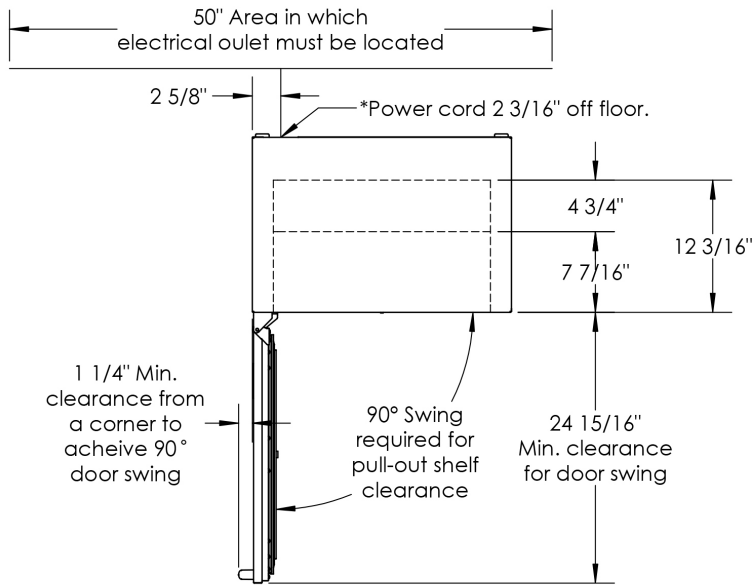

* - Leg levelers can add 3/4" to these dimensions when fully extended.

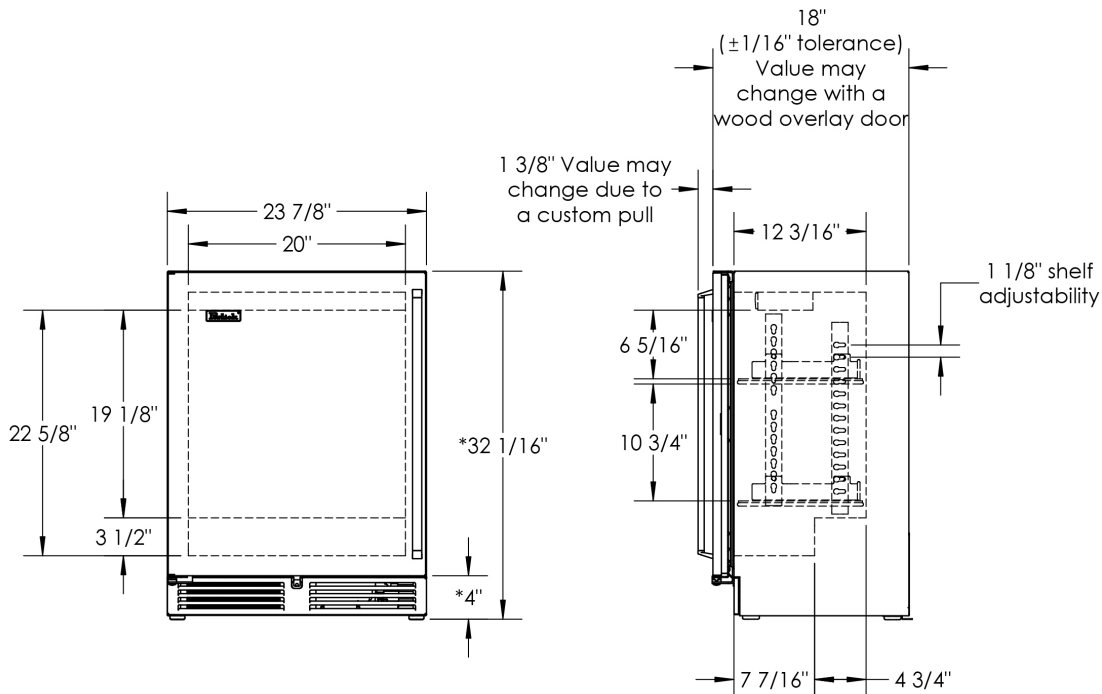

Form No. HH24RS-3
Rev. 1.08.2015