



TABLE OF CONTENTS

	Page
The Hydrotap Effect	3
Build Your Hydrotap System	4
Underbench Base Units	6
Classic Faucets	8
Arc Faucets	9
Cube Faucets	10
Celsius All-In-One Faucets	11
Fonts and Other Accessories	12
Technical Information	13
Terms and Conditions of Sale	15

Stock items are listed in red; however, inventory levels are subject to change. In order to plan your purchases accordingly we encourage you to check our live inventory by accessing the dealer login on www.pinnaclesalesgroup.com



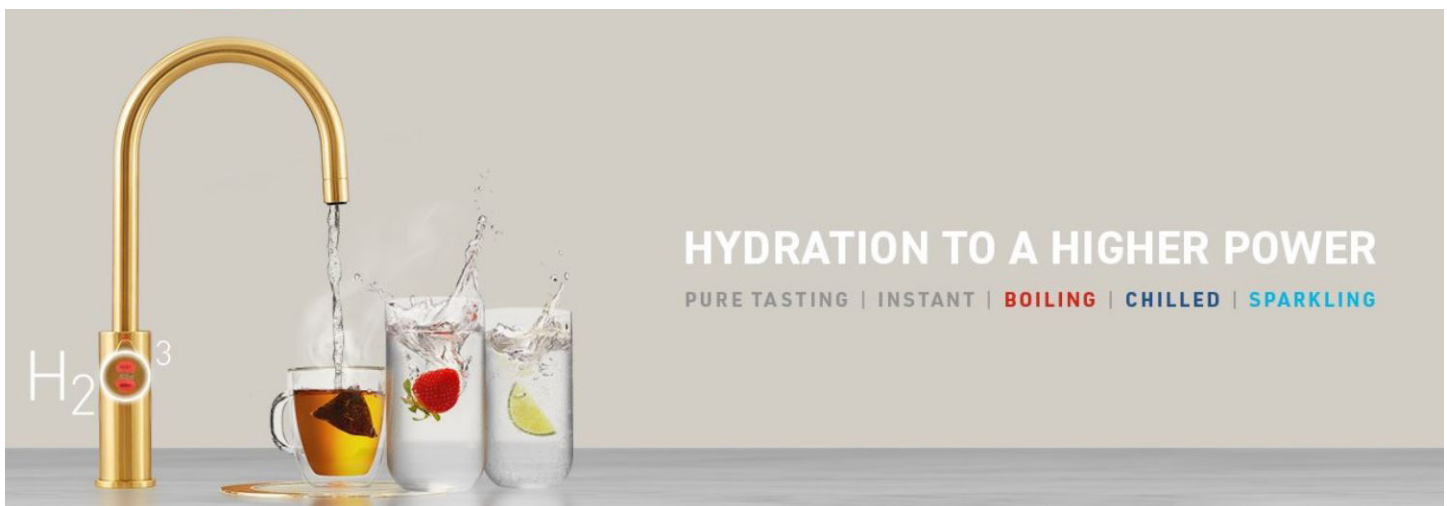

This price list supercedes all prices found in previous price lists and is subject to change without notice.

THE HYDROTAP EFFECT

70 YEARS OF INNOVATION	Founded in 1947, Zip Water is known globally for their advancements in residential drinking water systems.
WATER FOR EVERY TASTE PALATE	Provides instant filtered boiling, chilled and sparkling water at your fingertips.
ENERGY EFFICIENT	Reduces power consumption by up to 30% and costs approximately \$1.00 per week to operate.
GOOD FOR THE ENVIRONMENT	Reduces your environmental impact by eliminating the need for bottled water.
ADVANCED FILTRATION	Safely filters down to 0.2 micron removing taste, odor, dirt, contaminants, lead and reducing levels of chlorine and microbiological cysts.
DESIGNS AND FINISHES	Faucets are available in 4 designs with options of up to 7 finishes
SAFE FOR ALL USERS	Cool touch faucet and boiling water safety lock makes Hydrotap the safe water dispensing choice for your family.
AFTER SALE SUPPORT	Hydrotap products hold a comprehensive parts and labor warranty for 2 years.



1. Choose your Water Option (Page 6)

				
FILTERED	FILTERED	FILTERED	FILTERED	UNFILTERED
BOILING CHILLED SPARKLING	BOILING CHILLED	CHILLED SPARKLING	BOILING CHILLED SPARKLING	HOT & COLD

2. Choose your Tap style (Pages 8-11)

			
CLASSIC	ARC	CUBE	CELSIUS ALL-IN-ONE

3. Choose your Finish (Pages 8-11)

Standard			Premium			
						
CHROME	BRUSHED CHROME	MATTE BLACK	ROSE GOLD	BRUSHED GOLD	NICKEL	BRUSHED NICKEL

						
Chrome	Brushed Chrome	Matte Black	Rose Gold	Brushed Gold	Nickel	Brushed Nickel



Winner of Kitchen + Bath Business Innovators Award for 2019 Kitchen Product of the Year

“
*Experience The Hydrotap Effect.
It's Water. Refreshed.*
”

“



UNDERBENCH BASE UNITS

BCS (BOILING, CHILLED, SPARKLING)

Features

- Single Unit that Provides Instant Filtered, Boiling, Chilled and Sparkling
- 2 Year Warranty
- 0.2 Micron Built-In Filtration
- Boiling Water Safety Mode on Faucet
- Refillable CO2 Cylinder
- Power-Pulse Technology Maintains Boiling Water Within 0.4°F of Set Temperature
- Air-Cooled Refrigeration System Allows System to Maintain 100% Water Efficiency
- Boiling Water is Factory Set at 209°F
- Chilled Water is Factory Set at 44°F
- Sparkling Water is Factory Set at 44°F
- BCS120V-1 Capacity
85 cups of Boiling Water per Hour - 120v
75 cups of Chilled or Sparkling Water Per Hour
- BCS240V-1 Capacity
100 Cups of Boiling Water per Hour - 240v
75 Cups of Chilled or Sparkling Water per Hour
- BCS240V-1C Capacity
160 Cups of Boiling Water per Hour
175 Cups of Chilled or Sparkling Water per Hour

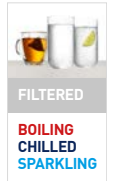

Now Available in 120v-240v Installation



Item Number	Description	MSRP
BCS120V-1	Boiling, Chilled, Sparkling Kit Unit, CO2, Regulator, 120v	\$3,910
BCS240V-1	Boiling, Chilled, Sparkling Kit Unit, 2kW, CO2, Regulator, 240v	\$3,910
BCS240V-1C	Boiling, Chilled, Sparkling Kit Unit, Large Commercial, CO2, Regulator, 240v	\$5,300

BC (BOILING, CHILLED)

Features

- Single Unit that Provides Instant Filtered, Boiling and Chilled Water
- 2 Year Warranty
- 0.2 Micron Built-In Filtration
- Boiling Water Safety Mode on Faucet
- Power-Pulse Technology Maintains Boiling Water Within 0.4°F of Set Temperature
- Air-Cooled Refrigeration System Allows System to Maintain 100% Water Efficiency
- Boiling Water is Factory Set at 209°F
- Chilled Water is Factory Set at 44°F
- BC120V-1 Capacity
85 cups of Boiling Water per Hour - 120v
75 cups of Boiling Per Hour Water
- BC240V-1 Capacity
100 Cups of Boiling Water per Hour - 240v
75 Cups of Chilled Water per Hour
- BC240V-1C Capacity
160 Cups of Boiling Water per Hour
125 Cups of Chilled Water per Hour

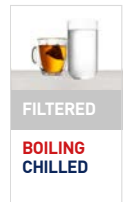

Item Number	Description	MSRP
BC120V-1	Boiling, Chilled Kit Unit, CO2, Regulator, 120v	\$3,400
BC240V-1	Boiling, Chilled Unit 2kW, 240v	\$3,400
BC240V-1C	Boiling, Chilled Unit, Large Commercial, 240v	\$4,500

CS (CHILLED, SPARKLING)

Features

- Single Unit that Provides Instant Filtered, Chilled and Sparkling Water
- 2 Year Warranty
- 0.2 Micron Built-In Filtration
- Refillable CO2 Cylinder
- Air-Cooled Refrigeration System Allows System to Maintain 100% Water Efficiency
- Chilled Water is Factory Set at 44°F
- Sparkling Water is Factory Set at 44°F
- CS120V-1 Capacity
75 Cups of Chilled or Sparkling Water per Hour
- CS240V-1 Capacity
75 Cups of Chilled or Sparkling Water per Hour
- CS240V-1C Capacity
175 Cups of Chilled or Sparkling Water per Hour

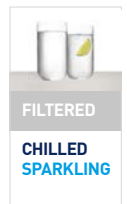

Item Number	Description	MSRP
CS120V-1	Chilled, Sparkling Kit Unit, Regulator, 120v	\$3,210
CS240V-1	Chilled, Sparkling Kit Unit, CO2, Regulator, 240v	\$3,210
CS240V-1C	Chilled, Sparkling Kit Unit, Large Commercial, CO2, Regulator, 240v	\$3,743

Optional accessories listed on page 12.

Inventory levels are subject to change, check stock via Dealer Login on www.pinnacle-salesgroup.com

UNDERBENCH BASE FEATURES

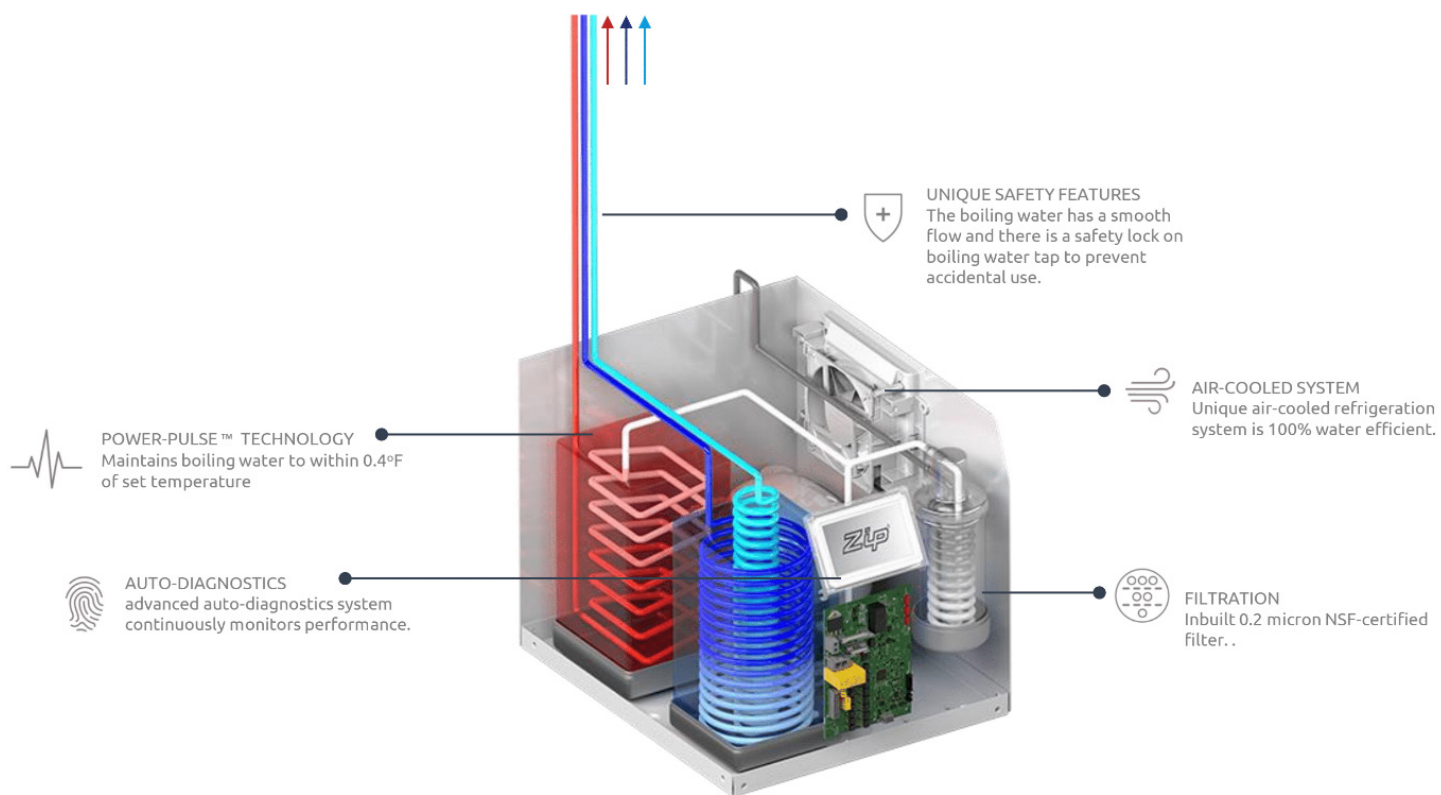

PRODUCT INSTALLATION

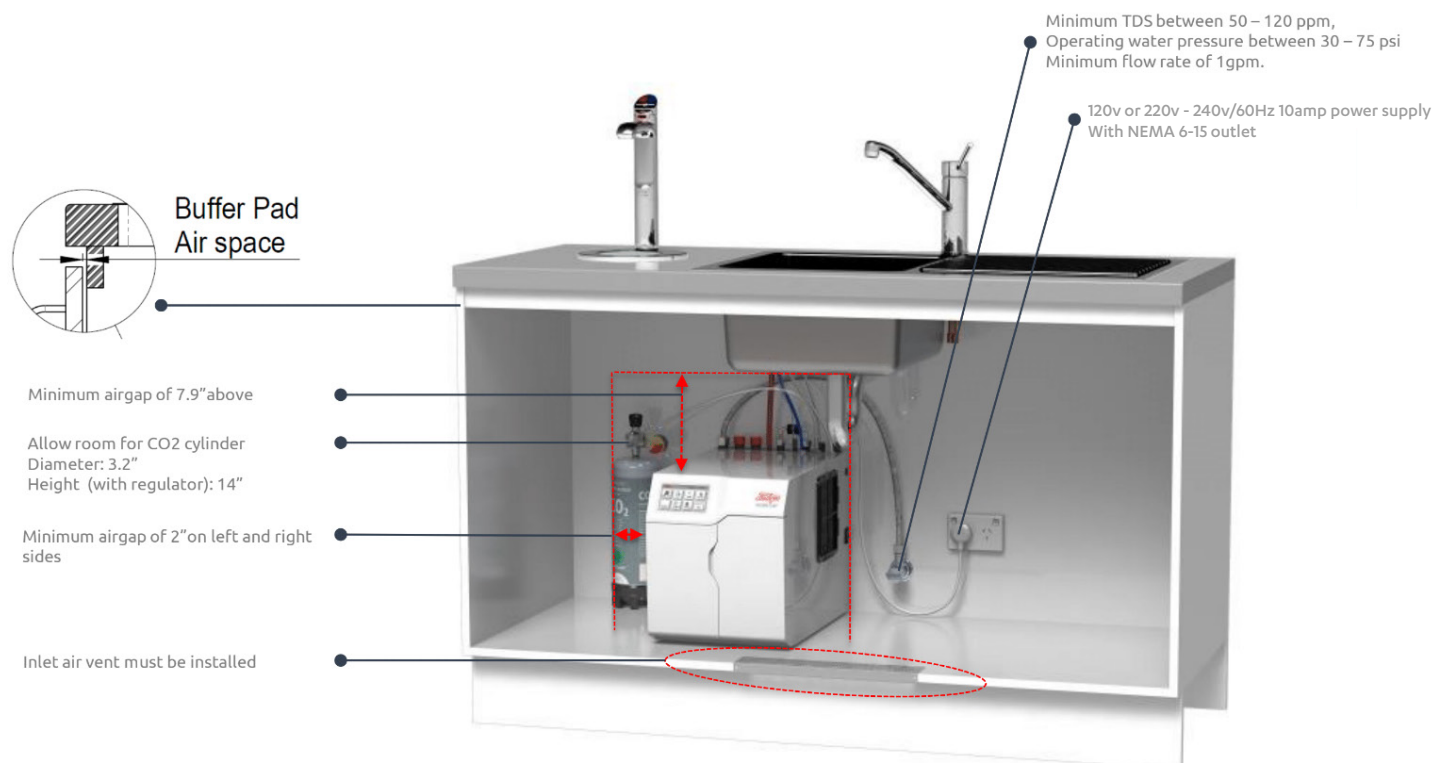

(Picture showing 240v installation, also available in 120v)

ZIP WATER FAUCETS CLASSIC

Features

- For use with BCS, BC or CS underbench units
- All water is filtered through a 0.2 micron cartridge
- Available in chrome, brushed chrome or matte black
- Installation over sink or with optional font
- Boiling water is only dispensed after safety lock is activated
- Chilled and sparkling water can be dispensed using “no-touch” technology



(Shown with font on Page 11)

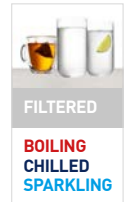

Boiling | Chilled | Sparkling Faucet Only

Item Number	Description	MSRP
CLASSIC-BCS-C	Faucet, Classic BCS, Chrome	\$695
CLASSIC-BCS-BC	Faucet, Classic BCS, Brushed Chrome	\$995
CLASSIC-BCS-MB	Faucet, Classic BCS, Matte Black	\$995

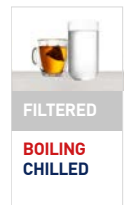

Boiling | Chilled Faucet Only

Item Number	Description	MSRP
CLASSIC-BC-C	Faucet, Classic BC, Chrome	\$695
CLASSIC-BC-BC	Faucet, Classic BC, Brushed Chrome	\$995
CLASSIC-BC-MB	Faucet, Classic BC, Matte Black	\$995

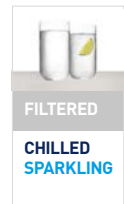

Chilled | Sparkling Faucet Only

Item Number	Description	MSRP
CLASSIC-CS-C	Faucet, Classic CS, Chrome	\$695
CLASSIC-CS-BC	Faucet, Classic CS, Brushed Chrome	\$995
CLASSIC-CS-MB	Faucet, Classic CS, Matte Black	\$995

AVAILABLE IN :

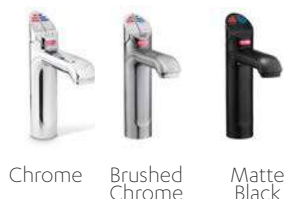

Chrome Brushed Chrome Matte Black

Optional accessories listed on page 12.

Inventory levels are subject to change, check stock via Dealer Login on www.pinnaclesalesgroup.com

STOCK ITEMS LISTED IN RED

ZIP WATER FAUCETS

ARC



Features

- For use with BCS, BC or CS underbench units
- All water is filtered through a 0.2 micron cartridge
- Available in 7 finishes
- Installation over sink or with optional font
- Boiling water is only dispensed after safety lock is activated

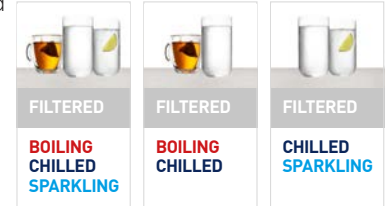

Faucets - Arc (for use with BCS, BC, CS)

Item Number	Description	MSRP
ARC-C	Faucet, ARC BCS, Chrome	\$695
ARC-BC	Faucet, ARC BCS, Brushed Chrome	\$995
ARC-MB	Faucet, ARC BCS, Matte Black	\$995
ARC-RG	Faucet, ARC BCS, Rose Gold	\$995
ARC-BG	Faucet, ARC BCS, Brushed Gold	\$995
ARC-N	Faucet, ARC BCS, Nickel	\$995
ARC-BN	Faucet, ARC BCS, Brushed Nickel	\$995

AVAILABLE IN :



Fonts for Arc and Cube Faucets



Item Number	Description	MSRP
DESIGN-FONT-C	Drip Tray, Design Font, Chrome	\$395
DESIGN-FONT-BC	Drip Tray, Design Font, Brushed Chrome	\$495
DESIGN-FONT-MB	Drip Tray, Design Font, Matte Black	\$495
DESIGN-FONT-RG	Drip Tray, Design Font, Rose Gold	\$495
DESIGN-FONT-BG	Drip Tray, Design Font, Brushed Gold	\$495
DESIGN-FONT-N	Drip Tray, Design Font, Nickel	\$495
DESIGN-FONT-BN	Drip Tray, Design Font, Brushed Nickel	\$495

Optional accessories listed on page 12.

Inventory levels are subject to change, check stock via Dealer Login on www.pinnaclesalesgroup.com

ZIP WATER FAUCETS

CUBE

Features

- For use with BCS, BC or CS underbench units
- All water is filtered through a 0.2 micron cartridge
- Available in 7 finishes
- Installation over sink or with optional front lock is activated
- Boiling water is only dispensed after safety lock is activated



Faucets - Cube (for use with BCS, BC, CS)

Item Number	Description	MSRP
CUBE-C	Faucet, CUBE BCS, Chrome	\$695
CUBE-BC	Faucet, CUBE BCS, Brushed Chrome	\$995
CUBE-MB	Faucet, CUBE BCS, Matte Black	\$995
CUBE-RG	Faucet, CUBE BCS, Rose Gold	\$995
CUBE-BG	Faucet, CUBE BCS, Brushed Gold	\$995
CUBE-N	Faucet, CUBE BCS, Nickel Faucet	\$995
CUBE-BN	Faucet, CUBE BCS, Brushed Nickel	\$995

AVAILABLE IN :

Standard



Premium



Fonts for Arc and Cube Faucets



Item Number	Description	MSRP
DESIGN-FONT-C	Drip Tray, Design Font, Chrome	\$395
DESIGN-FONT-BC	Drip Tray, Design Font, Brushed Chrome	\$495
DESIGN-FONT-MB	Drip Tray, Design Font, Matte Black	\$495
DESIGN-FONT-RG	Drip Tray, Design Font, Rose Gold	\$495
DESIGN-FONT-BG	Drip Tray, Design Font, Brushed Gold	\$495
DESIGN-FONT-N	Drip Tray, Design Font, Nickel	\$495
DESIGN-FONT-BN	Drip Tray, Design Font, Brushed Nickel	\$495

Optional accessories listed on page 12.

Inventory levels are subject to change, check stock via Dealer Login on www.pinnaclesalesgroup.com

STOCK ITEMS LISTED IN RED

ZIP WATER FAUCETS CELSIUS ALL-IN-ONE



Features

- For use with BCS underbench unit only
- Boiled, chilled and sparkling water are all filtered through a 0.2 micron cartridge
- Standard Hot and Cold Function
- Requires hot and cold water supply for installation
- Available in 7 finishes
- Installation over sink only
- Boiling water is only dispensed after safety lock is activated

FILTERED	UNFILTERED
BOILING CHILLED SPARKLING	HOT & COLD

Faucets - Celsius (for use with BCS only)

Item Number	Description	MSRP
CELSIUS-BCS-C	Faucet, Celsius AIO BCS, Chrome	\$1,195
CELSIUS-BCS-BC	Faucet, Celsius AIO BCS, Brushed Chrome	\$1,495
CELSIUS-BCS-MB	Faucet, Celsius AIO BCS, Matte Black	\$1,495
CELSIUS-BCS-RG	Faucet, Celsius AIO BCS, Rose Gold	\$1,495
CELSIUS-BCS-BG	Faucet, Celsius AIO BCS, Brushed Gold	\$1,495
CELSIUS-BCS-N	Faucet, Celsius AIO BCS, Nickel	\$1,495
CELSIUS-BCS-BN	Faucet, Celsius AIO BCS, Brushed Nickel	\$1,495

THIS PRODUCT NEEDS A HOT AND COLD WATER SUPPLY

AVAILABLE IN :

Standard



Chrome



Brushed Chrome



Matte Black

Premium



Rose Gold



Brushed Gold



Nickel



Brushed Nickel

Optional accessories listed on page 12.

Inventory levels are subject to change, check stock via Dealer Login on www.pinnacleexpress.com



FONTS

Fonts for Classic Faucets



Item Number	Description	MSRP
CLASSIC-FONT-C	Drip Tray, Classic Font, Chrome	\$395
CLASSIC-FONT-BC	Drip Tray, Classic Font, Brushed Chrome	\$495
CLASSIC-FONT-MB	Drip Tray, Classic Font, Matte Black	\$495

Fonts for Arc and Cube Faucets



Item Number	Description	MSRP
DESIGN-FONT-C	Drip Tray, Design Font, Chrome	\$395
DESIGN-FONT-BC	Drip Tray, Design Font, Brushed Chrome	\$495
DESIGN-FONT-MB	Drip Tray, Design Font, Matte Black	\$495
DESIGN-FONT-RG	Drip Tray, Design Font, Rose Gold	\$495
DESIGN-FONT-BG	Drip Tray, Design Font, Brushed Gold	\$495
DESIGN-FONT-N	Drip Tray, Design Font, Nickel	\$495
DESIGN-FONT-BN	Drip Tray, Design Font, Brushed Nickel	\$495

ACCESSORIES



Item Number	Description	MSRP
01034277	Replacement Filter, Zip, 0.2 Micron, 1.5 Size	\$195
01034347	Zip 2 x 1.5lb CO2 Refillable/Recyclable Cylinders	\$179
01034348	Zip 1 x 5lb CO2 Refillable/Recyclable Cylinder	\$199
01034349	Zip CO2 Regulator	\$149
01034280	Vent Tray, BC/BCS Models	\$150
01034281	Vent Tray, CS Models	\$150
01037879	Zip Scale Filter Installation Kit (2x Braided Hoses & Filter Head) - FL401	\$ 168.39
01037880	Zip PEX Lined Braided Hoses x 2 - 10mm Bore x 750mm - SR60013	\$ 29.82
01037881	Zip Scale Filter Head - 94527	\$ 101.02
01037868	Zip Scale Prevention Filter 2,250 liters (595 Gallons) - Replacement Cartridge - FL250	\$ 205.18
01037869	Zip Scale Prevention Filter 3,750 liters (990 Gallons) - Replacement Cartridge - FL500	\$ 239.71
01037870	Zip Scale Prevention Filter 7,000 liters (1,850 Gallons) - Replacement Cartridge - FL1000	\$ 334.15
01037871	Zip Scale Prevention Filter 10,000 liters (2,640 Gallons) - Replacement Cartridge - FL1500	\$ 447.83

Optional accessories listed on page 12.

Inventory levels are subject to change, check stock via Dealer Login on www.pinnaclesalesgroup.com



TECHNICAL INFORMATION

**Now Available in
120v-240v Installation**

FAUCETS

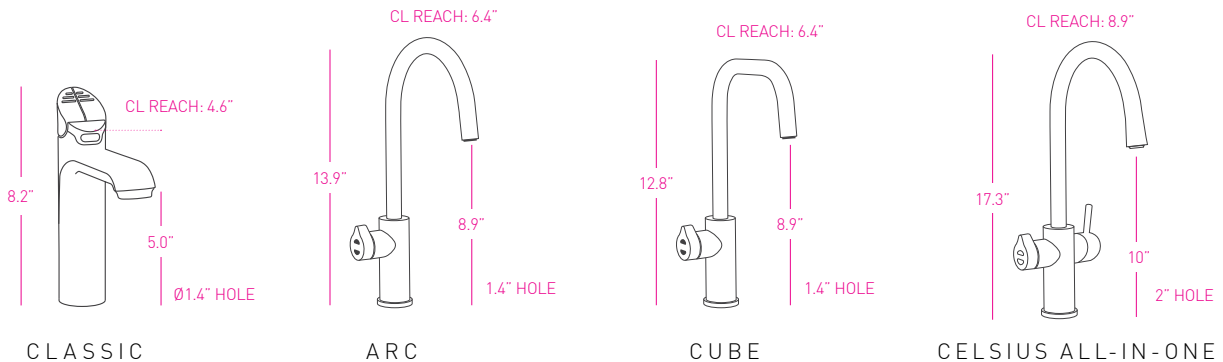

UNDERBENCH UNITS

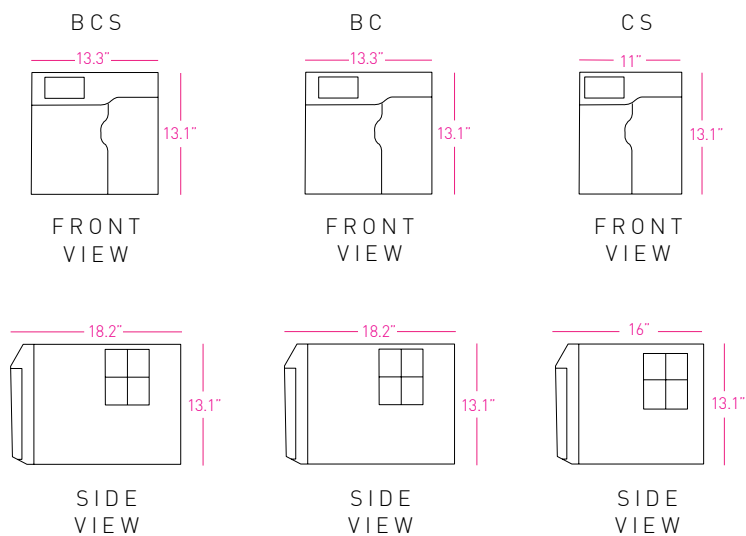

FONTS

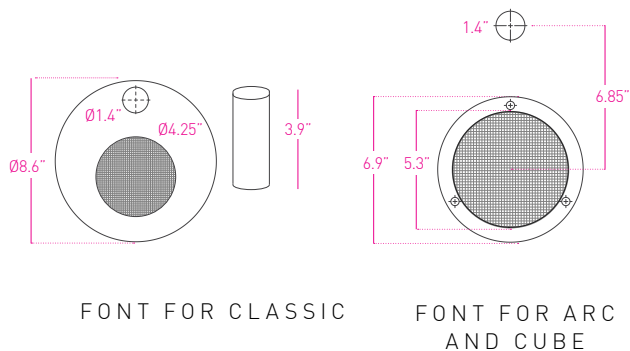

VENT TRAY

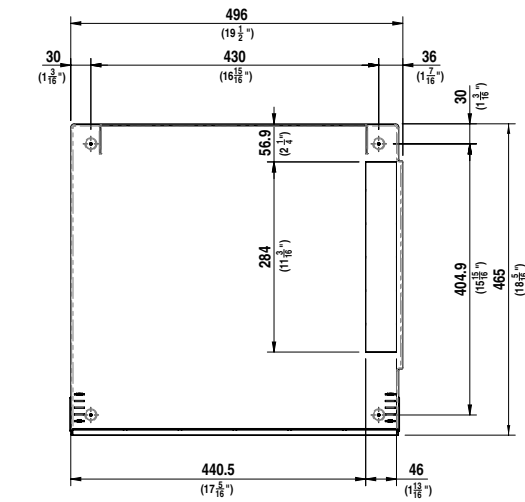

TOP VIEW
(FRONT COVER REMOVED FOR CLARITY)

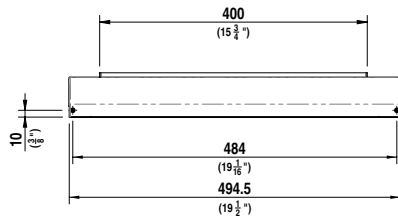

FRONT VIEW



RHS VIEW

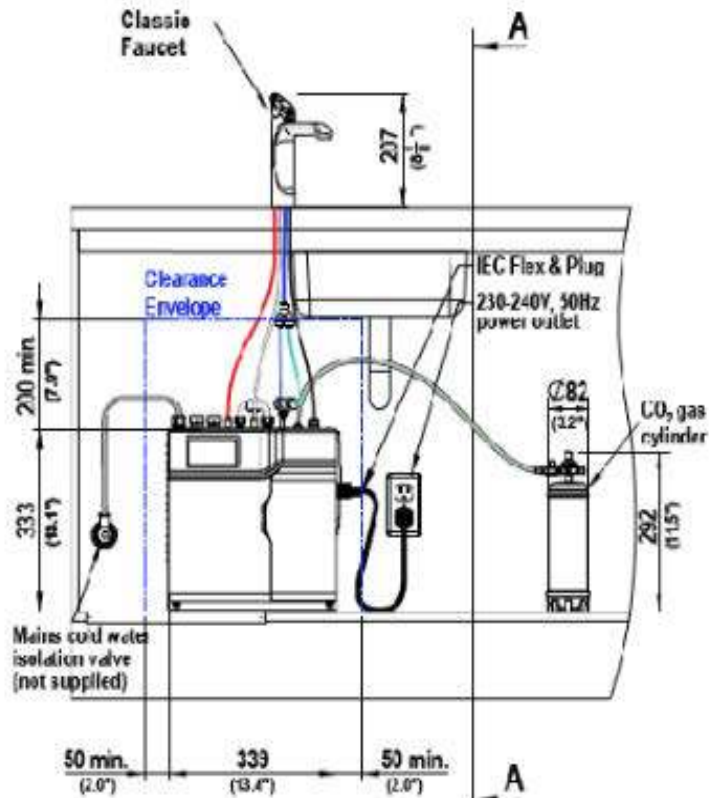
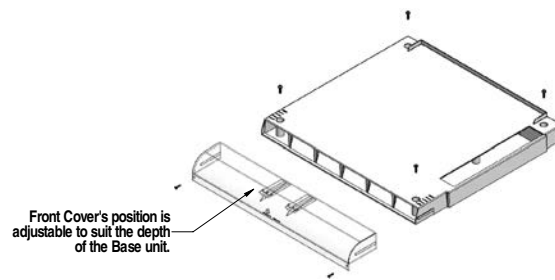

Orders: All orders and any subsequent change orders must be submitted in writing and delivered to Pinnacle Express, Inc. by mail, fax or e-mail. No telephone orders will be accepted. Special Order items are Non-Cancellable.

Prices: All prices are subject to change without notice and are exclusive of any sales or use taxes, shipping, delivery, special packaging, or handling charges that may apply to each customer or to each order.

Minimum Advertised Pricing: All sales are subject to Pinnacle Express, Inc. minimum advertised prices. Failure to comply with minimum advertised prices will result in cancellation of any agreement and violators will not be entitled to purchase further products.

Minimum Sale Price: All sales are subject to Pinnacle Express, Inc. minimum sale prices. Failure to comply with minimum sale prices will result in cancellation of any agreement and violators will not be entitled to purchase further products.

Freight and Handling: Pinnacle Express, Inc. reserves the right to ship products by its choice of carrier. All shipments are F.O.B. from place of shipment, and risk of loss shall pass to the Buyer upon delivery to the carrier at the point of shipment. Additional charges may apply for special handling and packaging.

Deliveries: Pinnacle Express, Inc. shall not be liable for failure to deliver or for delays in delivery or performance due to: (1) causes beyond its reasonable control; (2) acts of God, acts of Buyer, acts of civil or military authority, governmental allocations or controls, fires, strikes or other labor difficulties, riots or other civil disturbances, delays in its usual source of supply, delays in transportation; (3) any other commercial impracticability. In the event of such delay, the date of delivery or performance shall be extended for a period equal to the time lost by reason of the delay.

Claims: All claims for non-conforming delivery of Products must be made within twelve (12) days of receipt of shipment.

Damage or Loss: Any claim for damage or loss in shipment should be made to the carrier immediately by the customer. Products become the responsibility of the Buyer when accepted by the carrier in good condition from Pinnacle Express, Inc. and we are not able to process shipping damage claims.

Returns: Only Items marked in this Price List as "Stock Item" are subject to return. All other items are considered Special Order Items and are NOT RETURNABLE. No Products may be returned without a Pinnacle Express, Inc. Return Goods Authorization (RGA) Number issued prior to the return of Product. Any product returned without an RGA will be refused and returned to the sender. RGA's are valid for thirty (30) days only. All returns are subject to inspection before being approved for credit - products must be in saleable condition to be considered for return or replacement. A 30% restocking charge will apply to all returns.

Payment: Unless otherwise noted, payment terms are Net Due on Receipt. Balances owed on invoices over 30 days old are subject to a 1.5% per month charge. Each shipment or delivery shall be deemed to have been sold under a separate and or independent contract and payment thereof shall be made in accordance with the terms of this agreement and of the invoice rendered by Pinnacle Express, Inc. Buyer agrees that title to the personal property described herein shall not vest in Buyer until paid in full. In the event of insolvency or the filing of bankruptcy by the Buyer, Buyer agrees to return all merchandise to Pinnacle Express, Inc.

Warranties: Products distributed by Pinnacle Express, Inc. are the products of reputable manufacturers sold under their respective brand or trade names. Pinnacle Express, Inc. shall use its best efforts to obtain from each manufacturer, in accordance with the manufacturer's warranty or customary practice, the repair or replacement of products that may prove defective in material or workmanship. The foregoing shall constitute the exclusive remedy of the Buyer and the sole obligation of Pinnacle Express, Inc. with the exception of the Lifetime Warranty Program for Everpure Drinking Water Systems. This special warranty extends the manufacturer's 12-month limited warranty on an annual basis as long as the owner of an Everpure Drinking Water System can provide documentary evidence of purchase and installation of appropriate Everpure replacement cartridges. Except as to Title, THERE ARE NO WARRANTIES, EITHER WRITTEN, ORAL, IMPLIED, OR STATUTORY relating to the described products which shall extend beyond that described in this paragraph. NO WARRANTY OF MERCHANTABILITY OR OF FITNESS FOR PURPOSE SHALL APPLY.

Limitation of Liability: Pinnacle Express, Inc.'s liability on any claims for loss or damage arising out of this contract or from the performance or breach thereof or connected with the supplying of products hereunder, or its sale, resale, operation or use, whether based on warranty, contract, negligence or other grounds shall not exceed the price allowable for such products or parts thereof involved in the claim. Pinnacle Express, Inc. shall not, under any circumstances, be liable for any labor charges unless agreed upon in advance and in writing by Pinnacle Express, Inc. and the manufacturer of the products involved. Pinnacle Express, Inc. shall not in any event be liable for special or consequential damages, including, but not limited to, loss of profits or revenue, loss of use of the product or any associated product, cost of capital, cost of substitute products, facilities or services, downtime costs, or claims of customers of the Buyer for such damages.

General: The possession of this Price List by anyone is not to be considered as an offer to sell any of the Products contained herein. This Price List supercedes all previous price lists or memorandums. Pinnacle Express, Inc.'s existing Trade Terms and Conditions remain in effect.

The above Terms and Conditions shall be a part of all Orders accepted by Pinnacle Express, Inc. and shall supercede any conflicting provisions of our customer's purchase orders. These terms and conditions are subject to change without notice.



ZW-PB-042020



Pinnacle Express, Inc.
P.O. Box 1836 • Dundee, FL 33838
P: 800-292-8374 • F: 800-574-8805
www.pinnacleexpress.com