



IT'S WATER. REFRESHED.

2021 HYDROTAP BY ZIP
RETAIL PRICE BOOK



Hydrotap by Zip Price Book

Effective May 1, 2021

Revised August 30, 2021

www.pinnacleexpress.com

800-292-8374

TABLE OF CONTENTS

	Page
The Hydrotap Difference	3
Build Your Hydrotap System	4
Underbench Base Units	6
Classic Faucets	8
Wave Touch-Free Faucets	9
Arc Faucets	10
Cube Faucets	11
Celsius All-In-One Faucets	12
Design Fonts and Other Accessories	13
Technical Information	14
Terms and Conditions of Sale	16

Stock items are listed in red; however, inventory levels are subject to change. In order to plan your purchases accordingly we encourage you to check our live inventory by accessing the dealer login on www.pinnaclesalesgroup.com

This price list supercedes all prices found in previous price lists and is subject to change without notice.

THE HYDROTAP DIFFERENCE

70 YEARS OF INNOVATION



Founded in 1947, Zip Water is known globally for their advancements in residential drinking water systems.

WATER FOR EVERY TASTE PALATE



Provides instant filtered boiling, chilled and sparkling water at your fingertips.

ENERGY EFFICIENT



Reduces power consumption by up to 30% and costs approximately \$1.00 per week to operate.

GOOD FOR THE ENVIRONMENT



Reduces your environmental impact by eliminating the need for bottled water.

ADVANCED FILTRATION



Safely filters down to 0.2 micron removing taste, odor, dirt, contaminants, lead and reducing levels of chlorine and microbiological cysts.

DESIGNS AND FINISHES



Faucets are available in 4 designs with options of up to 7 finishes

SAFE FOR ALL USERS



Cool touch faucet and boiling water safety lock makes Hydrotap the safe water dispensing choice for your family.





AFTER SALE SUPPORT



Hydrotap products hold a comprehensive parts and labor warranty for 2 years.



1. Choose your Water Option (Page 6)

				
FILTERED	FILTERED	FILTERED	FILTERED	UNFILTERED
BOILING CHILLED SPARKLING	BOILING CHILLED	CHILLED SPARKLING	BOILING CHILLED SPARKLING	HOT & COLD

2. Choose your Tap style (Pages 8-13)

				
CLASSIC	WAVE TOUCH FREE	ARC	CUBE	CELSIUS ALL-IN-ONE

3. Choose your Finish (Pages 8-13)

Standard			Premium				
							
CHROME	BRUSHED CHROME	MATTE BLACK	ROSE GOLD	BRUSHED GOLD	NICKEL	BRUSHED NICKEL	GUNMETAL

							
Chrome	Brushed Chrome	Matte Black	Rose Gold	Brushed Gold	Nickel	Brushed Nickel	Gunmetal



Winner of Kitchen + Bath Business Innovators Award for 2019 Kitchen Product of the Year

“
*Experience The Hydrotap Effect.
It's Water. Refreshed.*
”

“



UNDERBENCH BASE UNITS

BCS (BOILING, CHILLED, SPARKLING)

Features

- Single Unit that Provides Instant Filtered, Boiling, Chilled and Sparkling
- 2 Year Warranty
- 0.2 Micron Built-In Filtration
- Boiling Water Safety Mode on Faucet
- Refillable CO2 Cylinder
- Power-Pulse Technology Maintains Boiling Water Within 0.4°F of Set Temperature
- Air-Cooled Refrigeration System Allows System to Maintain 100% Water Efficiency
- Boiling Water is Factory Set at 209°F
- Chilled Water is Factory Set at 44°F
- Sparkling Water is Factory Set at 44°F
- BCS120V-1 Capacity
 - 85 cups of Boiling Water per Hour - 120v
 - 75 cups of Chilled or Sparkling Water Per Hour
- BCS240V-1C Capacity
 - 160 Cups of Boiling Water per Hour
 - 175 Cups of Chilled or Sparkling Water per Hour



Now Available in
120v-240v Installation

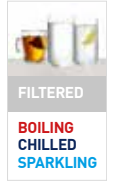

New Item Number	Previous Item Number	Description	MSRP
01038399	BCS120V-1	Boiling, Chilled, Sparkling Kit Unit, CO2, Regulator, 120v	\$4,003
01034469	BCS240V-1C	Boiling, Chilled, Sparkling Kit Unit, Large Commercial, CO2, Regulator, 240v	\$5,300

BC (BOILING, CHILLED)

Features

- Single Unit that Provides Instant Filtered, Boiling and Chilled Water
- 2 Year Warranty
- 0.2 Micron Built-In Filtration
- Boiling Water Safety Mode on Faucet
- Power-Pulse Technology Maintains Boiling Water Within 0.4°F of Set Temperature
- Air-Cooled Refrigeration System Allows System to Maintain 100% Water Efficiency
- Boiling Water is Factory Set at 209°F
- Chilled Water is Factory Set at 44°F
- BC120V-1 Capacity
 - 85 cups of Boiling Water per Hour - 120v
 - 75 cups of Boiling Per Hour Water
- BC240V-1 Capacity
 - 100 Cups of Boiling Water per Hour - 240v
 - 75 Cups of Chilled Water per Hour
- BC240V-1C Capacity
 - 160 Cups of Boiling Water per Hour
 - 125 Cups of Chilled Water per Hour

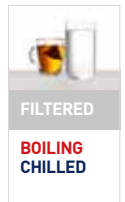

New Item Number	Previous Item Number	Description	MSRP
01037424	BC120V-1	Boiling, Chilled Kit Unit, CO2, Regulator, 120v	\$3,443
01034204	BC240V-1	Boiling, Chilled Unit 2kW, 240v	\$3,400
01034205	BC240V-1C	Boiling, Chilled Unit, Large Commercial, 240v	\$4,500

CS (CHILLED, SPARKLING)

Features

- Single Unit that Provides Instant Filtered, Chilled and Sparkling Water
- 2 Year Warranty
- 0.2 Micron Built-In Filtration
- Refillable CO2 Cylinder
- Air-Cooled Refrigeration System Allows System to Maintain 100% Water Efficiency
- Chilled Water is Factory Set at 44°F
- Sparkling Water is Factory Set at 44°F
- CS120V-1 Capacity
 - 75 Cups of Chilled or Sparkling Water per Hour
- CS240V-1 Capacity
 - 75 Cups of Chilled or Sparkling Water per Hour
- CS240V-1C Capacity
 - 175 Cups of Chilled or Sparkling Water per Hour

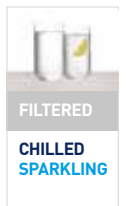

New Item Number	Previous Item Number	Description	MSRP
01038400	CS120V-1	Chilled, Sparkling Kit Unit, Regulator, 120v	\$3,443
01034468	CS240V-1	Chilled, Sparkling Kit Unit, CO2, Regulator, 240v	\$3,210
01034470	CS240V-1C	Chilled, Sparkling Kit Unit, Large Commercial, CO2, Regulator, 240v	\$3,743

Optional accessories listed on page 13.

Inventory levels are subject to change, check stock via Dealer Login on www.pinnaclesalesgroup.com

UNDERBENCH BASE FEATURES

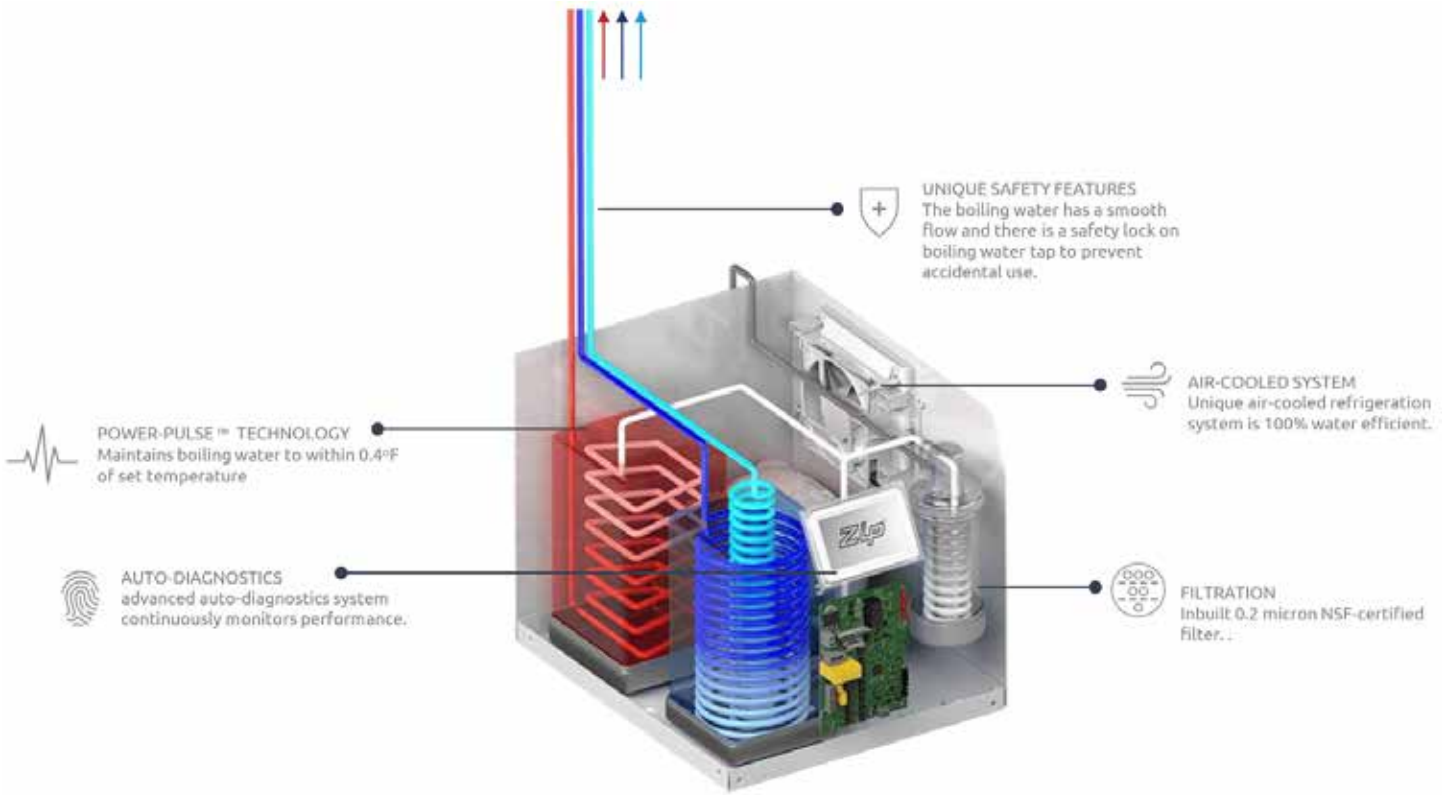

PRODUCT INSTALLATION

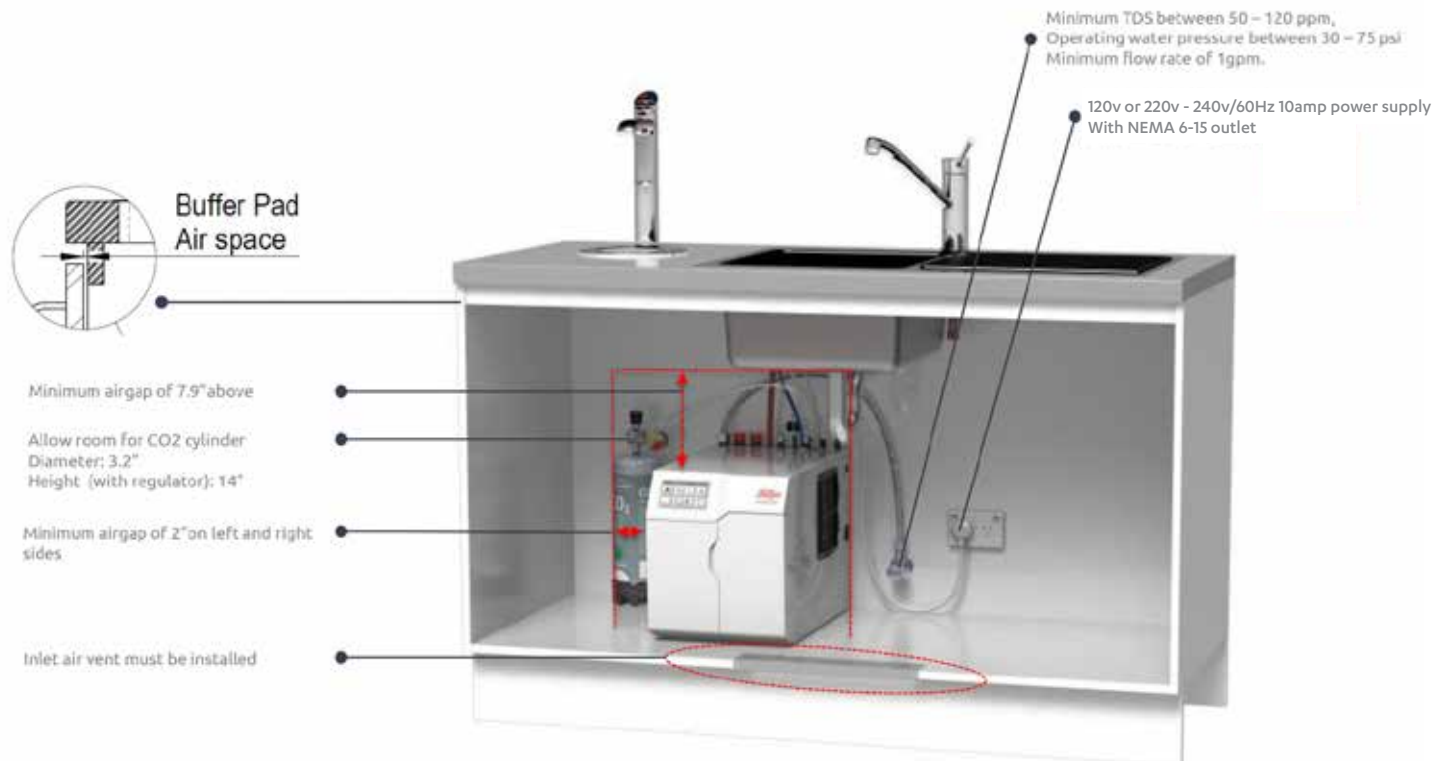

(Picture showing 240v installation, also available in 120v)

ZIP WATER FAUCETS

CLASSIC



(Shown with front on page 13)

Features

- For use with BCS, BC or CS underbench units
- All water is filtered through a 0.2 micron cartridge
- Available in chrome, brushed chrome or matte black
- Installation over sink or with optional font
- Boiling water is only dispensed after safety lock is activated
- Chilled and sparkling water can be dispensed using “no-touch” technology



Boiling | Chilled | Sparkling Faucet Only

New Item Number	Previous Item Number	Description	MSRP
01034208	CLASSIC-BCS-C	Faucet, Classic BCS, Chrome	\$695
01034209	CLASSIC-BCS-BC	Faucet, Classic BCS, Brushed Chrome	\$995
01034210	CLASSIC-BCS-MB	Faucet, Classic BCS, Matte Black	\$995

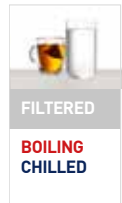

Boiling | Chilled Faucet Only

New Item Number	Previous Item Number	Description	MSRP
01034211	CLASSIC-BC-C	Faucet, Classic BC, Chrome	\$695
01034212	CLASSIC-BC-BC	Faucet, Classic BC, Brushed Chrome	\$995
01034213	CLASSIC-BC-MB	Faucet, Classic BC, Matte Black	\$995

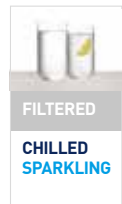

Chilled | Sparkling Faucet Only

New Item Number	Previous Item Number	Description	MSRP
01034214	CLASSIC-CS-C	Faucet, Classic CS, Chrome	\$695
01034215	CLASSIC-CS-BC	Faucet, Classic CS, Brushed Chrome	\$995
01034216	CLASSIC-CS-MB	Faucet, Classic CS, Matte Black	\$995

AVAILABLE IN :

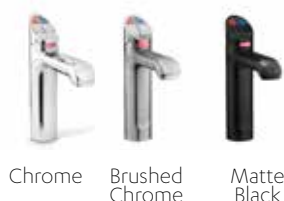

Chrome Brushed Chrome Matte Black

Fonts and optional accessories listed on page 13.

Inventory levels are subject to change, check stock via Dealer Login on www.pinnaclesalesgroup.com

STOCK ITEMS LISTED IN RED

ZIP WATER FAUCETS

WAVE TOUCH-FREE



Features

- For use with BCS, BC or CS underbench units
- All water is filtered through a 0.2 micron cartridge
- Available in chrome
- Water dispensed using “touch-free” technology
- Infrared smart sensors detect hand movement
- Safety function ensures that water will not dispense unless within 1.5” of sensor
- Installation over sink or with optional font
- Boiling water is only dispensed after safety lock is activated



Boiling | Chilled | Sparkling Faucet Only

New Item Number	Description	MSRP
01041859	Faucet, Wave BCS, Chrome	\$995



(Shown with font on page 13)

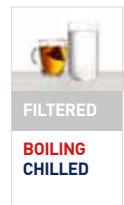

Boiling | Chilled Faucet Only

New Item Number	Description	MSRP
01041860	Faucet, Wave BC, Chrome	\$995

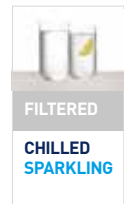

Chilled | Sparkling Faucet Only

New Item Number	Description	MSRP
01041861	Faucet, Wave CS, Chrome	\$995

AVAILABLE IN :



Chrome

Fonts and optional accessories listed on page 13.

Inventory levels are subject to change, check stock via Dealer Login on www.pinnaclesalesgroup.com

ZIP WATER FAUCETS

ARC

Features

- For use with BCS, BC or CS underbench units
- All water is filtered through a 0.2 micron cartridge
- Available in 8 finishes
- Installation over sink or with optional font (see page 13)
- Boiling water is only dispensed after safety lock is activated

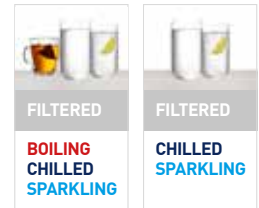

Boiling | Chilled | Sparkling or Chilled | Sparkling Faucet Only

New Item Number	Previous Item Number	Description	MSRP
01034217	ARC-C	Faucet, ARC BCS or CS, Chrome	\$695
01034218	ARC-BC	Faucet, ARC BCS or CS, Brushed Chrome	\$995
01034219	ARC-MB	Faucet, ARC BCS or CS, Matte Black	\$995
01034220	ARC-RG	Faucet, ARC BCS or CS, Rose Gold	\$995
01034221	ARC-BG	Faucet, ARC BCS or CS, Brushed Gold	\$995
01034222	ARC-N	Faucet, ARC BCS or CS, Nickel	\$995
01034223	ARC-BN	Faucet, ARC BCS or CS, Brushed Nickel	\$995
01041862	N/A	Faucet, ARC BCS or CS, Gunmetal	\$1,095



Boiling | Chilled Faucet Only

New Item Number	Previous Item Number	Description	MSRP
01034224	N/A	Faucet, ARC BC, Chrome	\$695
01034225	N/A	Faucet, ARC BC, Brushed Chrome	\$995
01034226	N/A	Faucet, ARC BC, Matte Black	\$995
01034227	N/A	Faucet, ARC BC, Rose Gold	\$995
01034228	N/A	Faucet, ARC BC, Brushed Gold	\$995
01034229	N/A	Faucet, ARC BC, Nickel	\$995
01034230	N/A	Faucet, ARC BC, Brushed Nickel	\$995
01041865	N/A	Faucet, ARC BC, Gunmetal	\$1,095

AVAILABLE IN :

Standard

Premium



Chrome

Brushed Chrome

Matte Black

Rose Gold

Brushed Gold

Nickel

Brushed Nickel

Gunmetal

Fonts and optional accessories listed on page 13.

Inventory levels are subject to change, check stock via Dealer Login on www.pinnaclesalesgroup.com

STOCK ITEMS LISTED IN RED

ZIP WATER FAUCETS

CUBE

Features

- For use with BCS, BC or CS underbench units
- All water is filtered through a 0.2 micron cartridge
- Available in 8 finishes
- Installation over sink or with optional font (see page 13)
- Boiling water is only dispensed after safety lock is activated

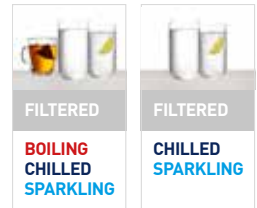

Boiling | Chilled | Sparkling or Chilled | Sparkling Faucet Only

New Item Number	Previous Item Number	Description	MSRP
01034238	CUBE-C	Faucet, CUBE BCS or CS, Chrome	\$695
01034239	CUBE-BC	Faucet, CUBE BCS or CS, Brushed Chrome	\$995
01034240	CUBE-MB	Faucet, CUBE BCS or CS, Matte Black	\$995
01034241	CUBE-RG	Faucet, CUBE BCS or CS, Rose Gold	\$995
01034242	CUBE-BG	Faucet, CUBE BCS or CS, Brushed Gold	\$995
01034243	CUBE-N	Faucet, CUBE BCS or CS, Nickel	\$995
01034244	CUBE-BN	Faucet, CUBE BCS or CS, Brushed Nickel	\$995
01041863	N/A	Faucet, CUBE BCS or CS, Gunmetal	NEW \$1,095

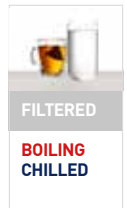

Boiling | Chilled Faucet Only

New Item Number	Previous Item Number	Description	MSRP
01034245	N/A	Faucet, CUBE BC, Chrome	\$695
01034246	N/A	Faucet, CUBE BC, Brushed Chrome	\$995
01034247	N/A	Faucet, CUBE BC, Matte Black	\$995
01034248	N/A	Faucet, CUBE BC, Rose Gold	\$995
01034249	N/A	Faucet, CUBE BC, Brushed Gold	\$995
01034250	N/A	Faucet, CUBE BC, Nickel	\$995
01034251	N/A	Faucet, CUBE BC, Brushed Nickel	\$995
01041866	N/A	Faucet, CUBE BC, Gunmetal	NEW \$1,095

AVAILABLE IN :

Standard



Chrome Brushed Chrome Matte Black

Premium



Rose Gold Brushed Gold Nickel Brushed Nickel Gunmetal

Fonts and optional accessories listed on page 13.

Inventory levels are subject to change, check stock via Dealer Login on www.pinnacleexpress.com

ZIP WATER FAUCETS CELSIUS ALL-IN-ONE



Features

- For use with BCS underbench unit only
- Boiled, chilled and sparkling water are all filtered through a 0.2 micron cartridge
- Standard Hot and Cold Function
- Requires hot and cold water supply for installation
- Available in 8 finishes
- Installation over sink only
- Boiling water is only dispensed after safety lock is activated

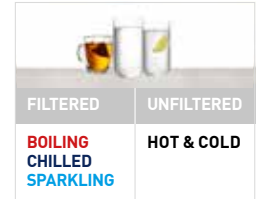

Boiling | Chilled | Sparkling All-In-One Faucet

New Item Number	Previous Item Number	Description	MSRP
01034259	CELSIUS-BCS-C	Faucet, Celsius AIO BCS, Chrome	\$1,195
01034260	CELSIUS-BCS-BC	Faucet, Celsius AIO BCS, Brushed Chrome	\$1,495
01034261	CELSIUS-BCS-MB	Faucet, Celsius AIO BCS, Matte Black	\$1,495
01034262	CELSIUS-BCS-RG	Faucet, Celsius AIO BCS, Rose Gold	\$1,495
01034263	CELSIUS-BCS-BG	Faucet, Celsius AIO BCS, Brushed Gold	\$1,495
01034264	CELSIUS-BCS-N	Faucet, Celsius AIO BCS, Nickel	\$1,495
01034265	CELSIUS-BCS-BN	Faucet, Celsius AIO BCS, Brushed Nickel	\$1,495
01041864	N/A	Faucet, Celsius AIO BCS, Gunmetal	NEW \$1,595

AVAILABLE IN :

Standard

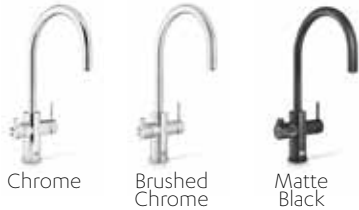

Chrome

Brushed Chrome

Matte Black

Premium



Rose Gold

Brushed Gold

Nickel

Brushed Nickel

Gunmetal

Optional accessories listed on page 13.

Inventory levels are subject to change, check stock via Dealer Login on www.pinnaclesalesgroup.com



FONTS



Fonts for Classic and Wave Faucets

New Item Number	Previous Item Number	Description	MSRP
01034266	CLASSIC-FONT-C	Drip Tray, Classic and Wave Font, Chrome	\$395
01034267	CLASSIC-FONT-BC	Drip Tray, Classic and Wave Font, Brushed Chrome	\$495
01034267	CLASSIC-FONT-MB	Drip Tray, Classic and Wave Font, Matte Black	\$495

Fonts for Arc and Cube Faucets



New Item Number	Previous Item Number	Description	MSRP
01034269	DESIGN-FONT-C	Drip Tray, Design Font, Chrome	\$395
01034270	DESIGN-FONT-BC	Drip Tray, Design Font, Brushed Chrome	\$495
01034271	DESIGN-FONT-MB	Drip Tray, Design Font, Matte Black	\$495
01034272	DESIGN-FONT-RG	Drip Tray, Design Font, Rose Gold	\$495
01034273	DESIGN-FONT-BG	Drip Tray, Design Font, Brushed Gold	\$495
01034274	DESIGN-FONT-N	Drip Tray, Design Font, Nickel	\$495
01034275	DESIGN-FONT-BN	Drip Tray, Design Font, Brushed Nickel	\$495
01041881	N/A	Drip Tray, Design Font, Gunmetal	NEW \$495

ACCESSORIES



Item Number	Description	MSRP
01034276	Replacement Filter, 0.2 Micron, 1 Size	\$175
01034277	Replacement Filter, 0.2 Micron, 1.5 Size	\$195
01034278	Replacement Filter, 0.3 Micron, 1.5 Size	\$195
01034347	Zip 2 x 1.5lb CO2 Refillable/Recyclable Cylinders	\$185
01034348	Zip 1 x 5lb CO2 Refillable/Recyclable Cylinder	\$199
01034349	Zip CO2 Regulator	\$159
01034280	Vent Tray, BC/BCS Models	\$150
01034281	Vent Tray, CS Models	\$150
01037879	Zip Scale Filter Installation Kit (2x Braided Hoses & Filter Head) - FL401	\$170
01037880	Zip PEX Lined Braided Hoses x 2 - 10mm Bore x 750mm - SR60013	\$29.99
01037881	Zip Scale Filter Head - 94527	\$102
01037867	Zip Scale Prevention Filter 1,700 liters (449 Gallons) - Replacement Cartridge - FL250	\$148
01037868	Zip Scale Prevention Filter 2,250 liters (595 Gallons) - Replacement Cartridge - FL250	\$205
01037869	Zip Scale Prevention Filter 3,750 liters (990 Gallons) - Replacement Cartridge - FL500	\$240
01037870	Zip Scale Prevention Filter 7,000 liters (1,850 Gallons) - Replacement Cartridge - FL1000	\$335
01037871	Zip Scale Prevention Filter 10,000 liters (2,640 Gallons) - Replacement Cartridge - FL1500	\$448
01037872	Zip Scale Prevention Filter 16,500 liters (4,359 Gallons) - Replacement Cartridge - FL1500	\$615

Inventory levels are subject to change, check stock via Dealer Login on www.pinnacleexpress.com



TECHNICAL INFORMATION

**Now Available in
120v-240v Installation**

FAUCETS

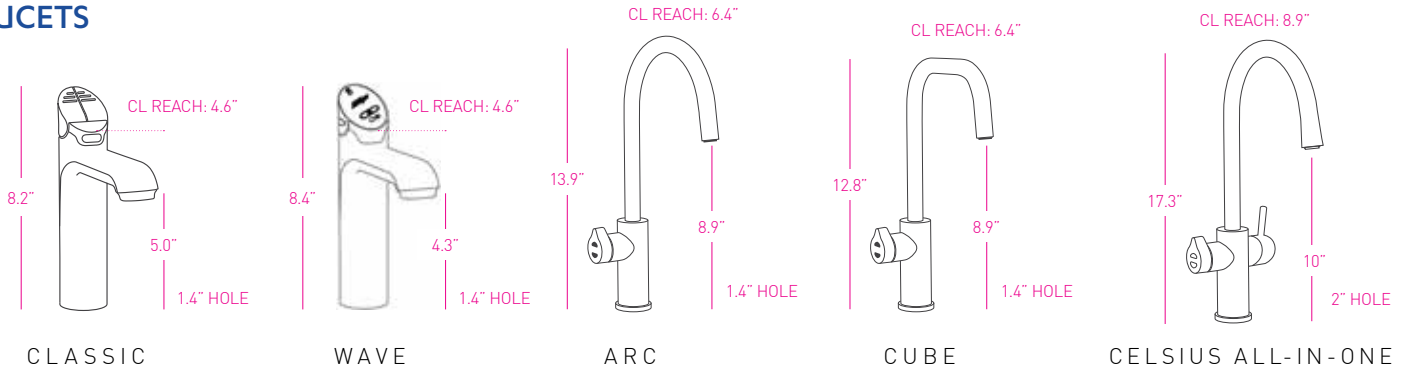

UNDERBENCH UNITS

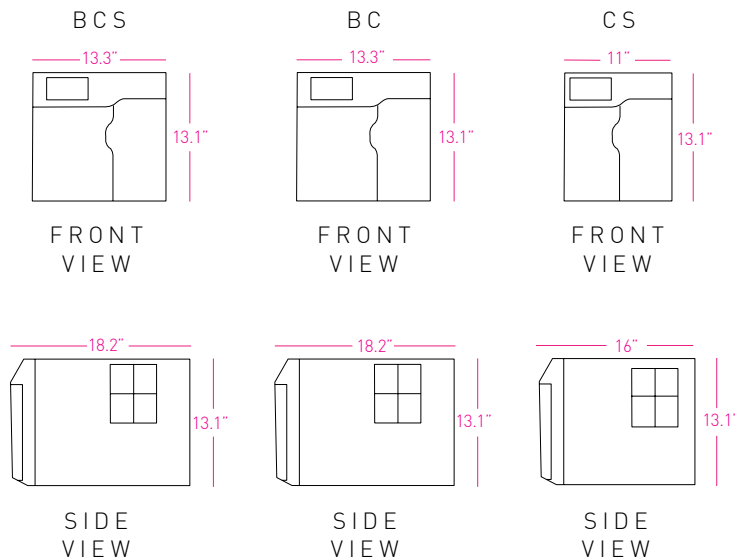

FONTS

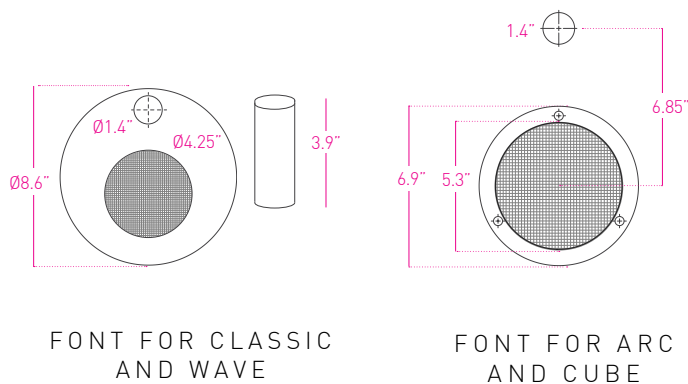

VENT TRAY

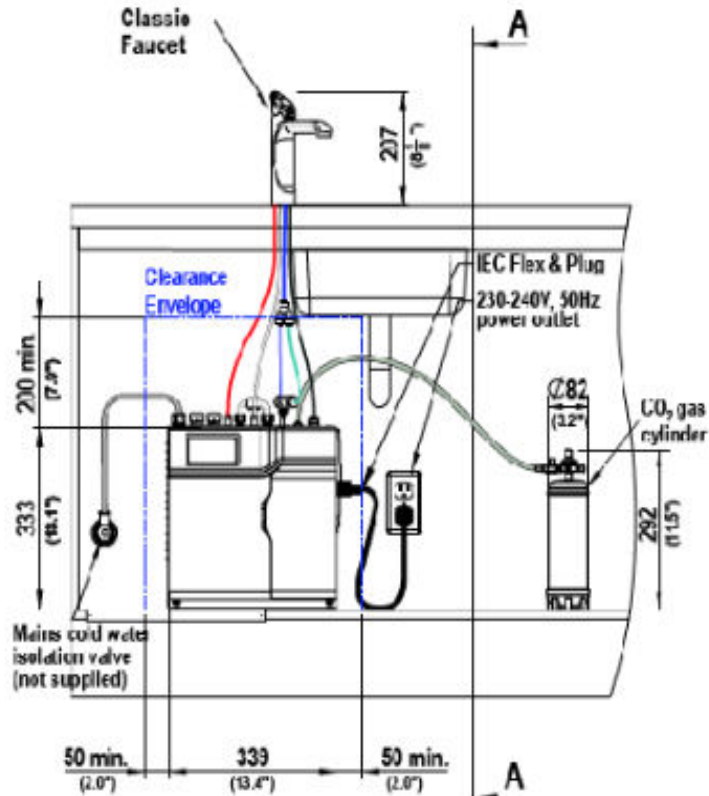
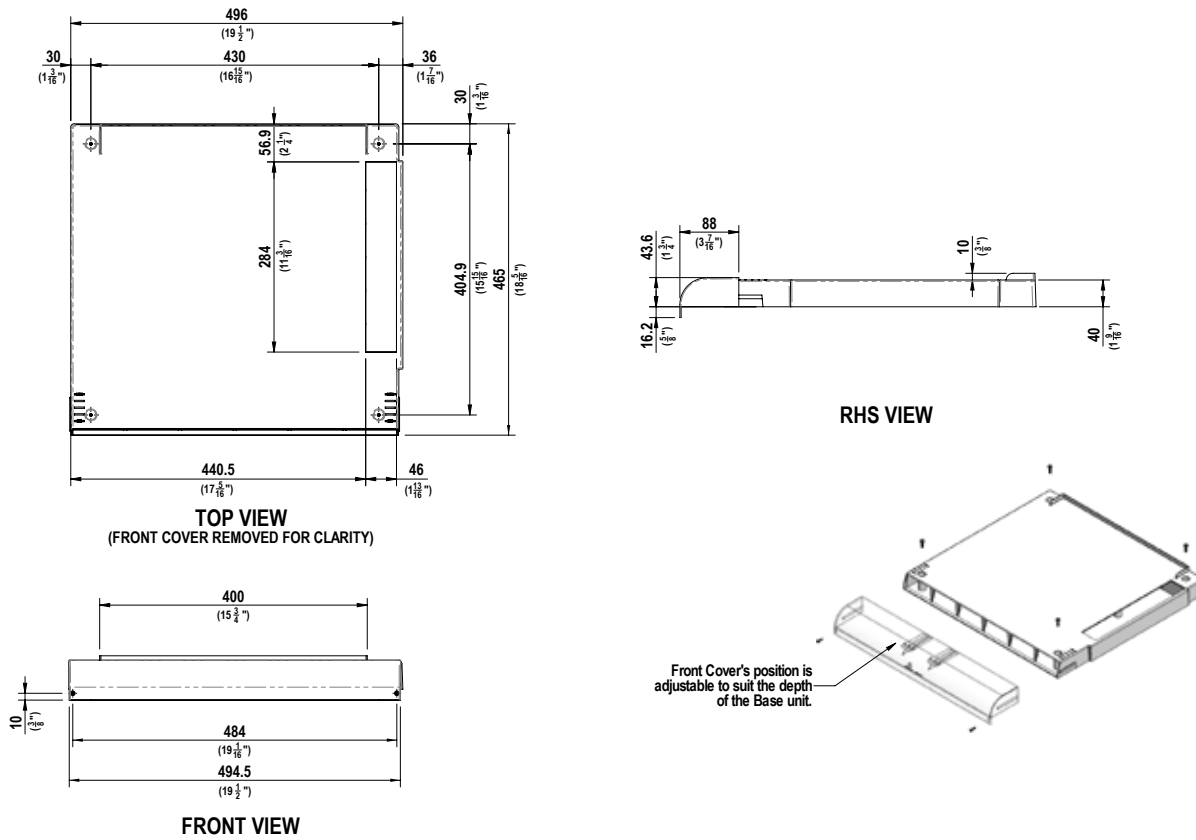

Orders: All orders and any subsequent change orders must be submitted in writing and delivered to Pinnacle Express, Inc. by mail, fax or e-mail. No telephone orders will be accepted. Special Order items are Non-Cancellable.

Prices: All prices are subject to change without notice and are exclusive of any sales or use taxes, shipping, delivery, special packaging, or handling charges that may apply to each customer or to each order.

Minimum Advertised Pricing: All sales are subject to Pinnacle Express, Inc. minimum advertised prices. Failure to comply with minimum advertised prices will result in cancellation of any agreement and violators will not be entitled to purchase further products.

Minimum Sale Price: All sales are subject to Pinnacle Express, Inc. minimum sale prices. Failure to comply with minimum sale prices will result in cancellation of any agreement and violators will not be entitled to purchase further products.

Freight and Handling: Pinnacle Express, Inc. reserves the right to ship products by its choice of carrier. All shipments are F.O.B. from place of shipment, and risk of loss shall pass to the Buyer upon delivery to the carrier at the point of shipment. Additional charges may apply for special handling and packaging.

Deliveries: Pinnacle Express, Inc. shall not be liable for failure to deliver or for delays in delivery or performance due to: (1) causes beyond its reasonable control; (2) acts of God, acts of Buyer, acts of civil or military authority, governmental allocations or controls, fires, strikes or other labor difficulties, riots or other civil disturbances, delays in its usual source of supply, delays in transportation; (3) any other commercial impracticability. In the event of such delay, the date of delivery or performance shall be extended for a period equal to the time lost by reason of the delay.

Claims: All claims for non-conforming delivery of Products must be made within twelve (12) days of receipt of shipment.

Damage or Loss: Any claim for damage or loss in shipment should be made to the carrier immediately by the customer. Products become the responsibility of the Buyer when accepted by the carrier in good condition from Pinnacle Express, Inc. and we are not able to process shipping damage claims.

Returns: Only Items marked in this Price List as "Stock Item" are subject to return. All other items are considered Special Order Items and are NOT RETURNABLE. No Products may be returned without a Pinnacle Express, Inc. Return Goods Authorization (RGA) Number issued prior to the return of Product. Any product returned without an RGA will be refused and returned to the sender. RGA's are valid for thirty (30) days only. All returns are subject to inspection before being approved for credit - products must be in saleable condition to be considered for return or replacement. A 30% restocking charge will apply to all returns.

Payment: Unless otherwise noted, payment terms are Net Due on Receipt. Balances owed on invoices over 30 days old are subject to a 1.5% per month charge. Each shipment or delivery shall be deemed to have been sold under a separate and or independent contract and payment thereof shall be made in accordance with the terms of this agreement and of the invoice rendered by Pinnacle Express, Inc. Buyer agrees that title to the personal property described herein shall not vest in Buyer until paid in full. In the event of insolvency or the filing of bankruptcy by the Buyer, Buyer agrees to return all merchandise to Pinnacle Express, Inc.

Warranties: Products distributed by Pinnacle Express, Inc. are the products of reputable manufacturers sold under their respective brand or trade names. Pinnacle Express, Inc. shall use its best efforts to obtain from each manufacturer, in accordance with the manufacturer's warranty or customary practice, the repair or replacement of products that may prove defective in material or workmanship. The foregoing shall constitute the exclusive remedy of the Buyer and the sole obligation of Pinnacle Express, Inc. with the exception of the Lifetime Warranty Program for Everpure Drinking Water Systems. This special warranty extends the manufacturer's 12-month limited warranty on an annual basis as long as the owner of an Everpure Drinking Water System can provide documentary evidence of purchase and installation of appropriate Everpure replacement cartridges. Except as to Title, THERE ARE NO WARRANTIES, EITHER WRITTEN, ORAL, IMPLIED, OR STATUTORY relating to the described products which shall extend beyond that described in this paragraph. NO WARRANTY OF MERCHANTABILITY OR OF FITNESS FOR PURPOSE SHALL APPLY.

Limitation of Liability: Pinnacle Express, Inc.'s liability on any claims for loss or damage arising out of this contract or from the performance or breach thereof or connected with the supplying of products hereunder, or its sale, resale, operation or use, whether based on warranty, contract, negligence or other grounds shall not exceed the price allowable for such products or parts thereof involved in the claim. Pinnacle Express, Inc. shall not, under any circumstances, be liable for any labor charges unless agreed upon in advance and in writing by Pinnacle Express, Inc. and the manufacturer of the products involved. Pinnacle Express, Inc. shall not in any event be liable for special or consequential damages, including, but not limited to, loss of profits or revenue, loss of use of the product or any associated product, cost of capital, cost of substitute products, facilities or services, downtime costs, or claims of customers of the Buyer for such damages.

General: The possession of this Price List by anyone is not to be considered as an offer to sell any of the Products contained herein. This Price List supercedes all previous price lists or memorandums. Pinnacle Express, Inc.'s existing Trade Terms and Conditions remain in effect.

The above Terms and Conditions shall be a part of all Orders accepted by Pinnacle Express, Inc. and shall supercede any conflicting provisions of our customer's purchase orders. These terms and conditions are subject to change without notice.

NOTES

Lined area for taking notes, consisting of multiple horizontal lines.

NOTES



Pinnacle Express, Inc.

P.O. Box 1836 • Dundee, FL 33838

Phone: 800-292-8374

Fax: 800-574-8805

www.pinnacleexpress.com