



A little about Fulgor Milano...

- 1949** Fulgor is founded as a coal-stove factory
- 1955** Fulgor first produces freestanding gas kitchen ranges
- 1974** Fulgor's built-in cooktops are created
- 1976** Fulgor's electric built-in ovens are first produced
- 1990** Creation of Fulgor's first built-in glass cooktop
- 1991** First European production of Fulgor's pyrolytic ovens
- 1994** First production of Fulgor's pyrolytic ovens for the North American market
- 2006** Meneghetti invents world's first dual-flame burner
- 2009** Fulgor celebrates 60 years; Fulgor Milano is born. A complete line of premium built-in appliances.
- 2016** Fulgor Milano introduced to North America
- 2024** Fulgor Milano celebrates 75 years



TABLE OF CONTENTS

	Page
About Fulgor Milano	2
Why Fulgor Milano?	6
Color Bezel Kits	8
48" Sofia Range	10
Explore our Built-In Refrigeration	11
Crescendo Burner	12
Ranges	14
Sofia Ranges	15
Accento Ranges	24
Rangetops	28
Gas Rangetops	29
Induction Rangetops	32
Cooktops	35
Gas Cooktops	36
Induction Cooktops	44
Radiant Cooktops	47
Ovens	49
Wall Ovens	50
Specialty Ovens	61
Warming Drawers	65
Microwave Ovens	67
Coffee Systems	71
Refrigeration	73
Column Refrigeration	76
Built-in Refrigeration	79
Freestanding Refrigeration	83
Dishwashers	84
Ventilation	89
Fulgor Milano Warranty and Service Information	96
Pinnacle Sales Group Terms & Conditions of Sale	97

Stock items are listed in red; however, inventory levels are subject to change. In order to plan your purchases accordingly we encourage you to check our live inventory by accessing the dealer login on www.pinnaclesalesgroup.com

FULGOR

MILANO

Fulgor Milano, an Italian brand by Meneghetti SPA, has been synonymous with excellence and innovation in the world of cooking since 1949. When Fulgor Milano became part of the Meneghetti family in 2009, the brand united its devotion to creativity with expert knowledge in the creation of premium built-in appliances.



A perfect balance of elegance, design, function and performance, this professional cooking line will satisfy the most discerning chef, while still providing a center piece for any kitchen design.

We invite you to explore Fulgor Milano premium kitchen appliances.



Why

FULGOR

MILANO



» DESIGN

Fulgor Milano celebrates Italian design with a focus on symmetry and elegance. From Sofia's bold presence to Matteo's refined precision, each piece blends stainless steel, brushed aluminum, and meticulous craftsmanship to create appliances that embody both beauty and balance, redefining the modern kitchen.

» PROFESSIONALLY CRAFTED (FIT, FINISH, QUALITY)

Fulgor Milano products combine all the features of fully-equipped professional ranges and cooking with a stainless steel design which highlights the elegance and uniqueness of Italian style.

» CRESCENDO BURNERS

Because precision is important for powerful high and gentle low flames, our sealed burners offer five combinations of flame configurations for near infinite control. Durable brass burner rings provide exceptional heat distribution to the base of the cooking vessel at its maximum output of 20,000 BTUs and is also capable of the gentlest simmer aided by its oversized burner cap.

» TOTAL CONTROL AND DELICATE POWER

Every aspect of Fulgor Milano is beautiful and our gas cooking surface is no exception. Every burner allows you to temper the most delicate chocolate or sear a steak to perfection.

» CAST IRON GRATES AND MATTE BURNER BASIN

Heavy-duty cast-iron grates form a continuous surface for easy movement of pots and pans. You'll barely notice spillovers in this recessed burner basin and they'll clean up easily, too.

» PERSONALIZE YOUR KITCHEN

Make your Fulgor Milano kitchen unmistakably yours with a complimentary, customizable nameplate and a choice of 7 finishes for your range and 3 bezel options—ensuring every detail reflects your personal style.

» CRAFTED IN ITALY

Made in Italy with a perfect balance of elegance, design, function and performance, this professional cooking brand will satisfy the most discerning chef, while still providing a center piece for any kitchen design.







FULGOR
MILANO

COLOR BEZEL KITS

FOR SOFIA RANGES, RANGETOPS AND WALL OVENS



VENETIAN BRASS

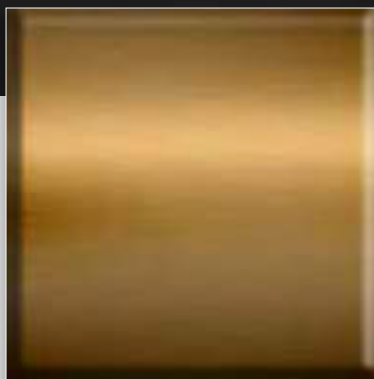

BRUSHED BRONZE



MATTE BLACK

- Please note that actual finishes may vary slightly from those depicted in our price book due to variations in screen settings and the nature of the material.

THE 48" **SOFIA** RANGE

Thoughtfully designed surface cooking with six burner positions, each with a 5-in-1 Crescendo burner beneath continuous cast iron grates and a Trilaminare stainless steel griddle, providing unparalleled power and control to melt, simmer, sauté and sear as you desire. Below the cooking surface, two self cleaning convection ovens with intuitive multiple baking and broiling functions and the convenience of telescoping racks encourages you to cook the way you want.



EXPLORE COLUMN REFRIGERATION



5 *in* 1

CRESCENDO BURNER



Because precision is important for powerful high and gentle low flames, our sealed burners offer five combinations of flame configurations for near infinite control. Durable brass burner rings provide exceptional heat distribution to the base of the cooking vessel at its maximum output of 20,000 BTU and is also capable of the gentlest simmer aided by its oversized burner cap.



FORTE

1

At the peak of its 20,000 BTU capability, meat is seared to produce a crust worthy of your favorite chef. Large pots quickly recover to a rigorous boil, and no culinary conquest seems unattainable. All burner rings engage to produce the most powerful flame for cooking.



MEZZOFORTE

2

Perfect al dente pasta is a snap. Progressive control of the burner ensures maximum heat distribution without excessive flame for an even and moderate boil.



MEZZO

3

Creamy risotto and smooth custards come to life as the burner rings combine to provide enough heat to encourage the cooking but discourage scorching.



PIANOFORTE

4

Simmer, poach, or braise your way to a tender sauce, soup or stew. Flame curls around the diffuser cap to barely brush the base of the cooking vessel with perfect control for extended periods of low heat cooking.



PIANO

5

Melt butter, temper chocolate, or gently coax the flavor from savory vegetables, this lowest setting is achieved by the flame from the simmer burner rolling gently under the diffuser cap to radiate whisper soft heat.

FULGOR

MILANO



RANGES

SOFIA Professional 600 Freestanding



SOFIA FREESTANDING RANGES - DUAL FUEL

F6PDF304S1

30" Dual Fuel Professional Range
Series: 600
AVAILABLE IN 7 FINISHES



RANGES

Cooking Surface

- 2 Heavy Duty, Continuous Cast Iron Grates
- One Piece, Matte Finish Porcelain Burner Bowl
- 4 Dual-Flame Crescendo Burners
- 1 Burner Provides Maximum 20,000 BTUs of Power
- 3 Burners Provide Maximum 18,000 BTUs of Power
- Simmer Setting adjustable to 375 BTUs
- Standard Natural Gas, LP Conversion Kit Included
- Cast Iron Island Trim

Oven

- Dual True Convection
- Self-Cleaning Oven with Multifunctioning Baking
- Black Porcelain Enamel Interior
- Cool to Touch, Soft-Closing Door
- Extra Large Baking Cavity
- 3 Halogen Lights for Flawless Visibility
- 4.4 cu. ft. Capacity
- 2 Chrome Racks
- 1 Telescopic Rack
- Enameled Broiler Pan
- Meat Probe
- Complimentary Personalized Nameplate
- "Sabbath Mode"



Product Information

MODEL	WIDTH	FINISH	DESCRIPTION	UMRP
F6PDF304S1	30"	Stainless Steel	Dual Fuel Professional Range	\$ 6,499

Optional Accessories

MODEL	DESCRIPTION	UMRP
PDRKIT30MG	Color Door Kit, Matte Slate Gray	\$ 1,119
PDRKIT30WH	Color Door Kit, Glossy White	\$ 1,119
PDRKIT30MW	Color Door Kit, Matte White	\$ 1,119
PDRKIT30RD	Color Door Kit, Glossy Red	\$ 1,119
PDRKIT30BK	Color Door Kit, Glossy Black	\$ 1,119
PDRKIT30MB	Color Door Kit, Matte Black	\$ 1,119
FMSBEZKIT06-BR	Small Bezel Kit for 30" Ranges, Venetian Brass	\$ 429
FMSBEZKIT06-BZ	Small Bezel Kit for 30" Ranges, Brushed Bronze	\$ 429
FMSBEZKIT06-MB	Small Bezel Kit for 30" Ranges, Matte Black	\$ 429
F6BG30ISL	30" Back Guard, Island Trim	\$ 149
F6BG30STD	30" Back Guard, Standard 3" Trim	\$ 229
F6BG30HBT	30" Back Guard, 9" Highback Trim	\$ 319
F6BG30BCI	30" Back Guard, Cast Iron Island Trim	\$ 159
FMWOK	Wok Ring	\$ 69
FMSIM	Simmer Plate	\$ 89
FMGRID30	Griddle, 30"	\$ 239
FMTRP30	Telescopic Rack, 30" Range	\$ 229
FMHAK30	High Altitude Kit, 30" Range	\$ 59

Inventory levels are subject to change, check stock via Dealer Login on www.pinnaclesalesgroup.com

SOFIA FREESTANDING RANGES - DUAL FUEL

F6PDF366S1 / F6PDF364GS1

36" Dual Fuel Professional Range

Series: 600

AVAILABLE IN 7 FINISHES



SOFIA
Professional 600
Freestanding

Cooking Surface

- 3 Heavy Duty, Continuous Cast Iron Grates -OR- 2 Heavy Duty, Continuous Cast Iron Grates with Trilaminar Stainless Steel Griddle w/ Tubular Burner
- One Piece Matte Finish Porcelain Burner Bowl
- 4-6 Dual-Flame Crescendo Burners
- 2 Burners Provide Maximum 20,000 BTUs of Power
- 2-4 Burners Provide Maximum 18,000 BTUs of Power
- Simmer Setting adjustable to 375 BTUs
- Standard Natural Gas, LP Conversion Kit Included
- Cast Iron Island Trim

Oven

- Dual True Convection
- Self Cleaning Oven with Multifunction Baking
- Black Porcelain Enamel Interior
- Cool to Touch, Soft-Closing Door
- Extra Large Baking Cavity
- 3 Halogen Lights for Flawless Visibility
- 5.7 cu. ft. Capacity
- 2 Chrome Racks
- 1 Telescopic Rack
- Enameled Broiler Pan
- Meat Probe
- Complimentary Personalized Nameplate "Sabbath Mode"



Product Information

MODEL	WIDTH	FINISH	DESCRIPTION	UMRP
F6PDF366S1	36"	Stainless Steel	Dual Fuel Professional Range	\$ 8,499
F6PDF364GS1	36"	Stainless Steel	Dual Fuel Professional Range with Griddle	\$ 9,299

Optional Accessories

MODEL	DESCRIPTION	UMRP
PDRKIT36MG	Color Door Kit, Matte Slate Gray	\$ 1,229
PDRKIT36WH	Color Door Kit, Glossy White	\$ 1,229
PDRKIT36MW	Color Door Kit, Matte White	\$ 1,229
PDRKIT36RD	Color Door Kit, Glossy Red	\$ 1,229
PDRKIT36BK	Color Door Kit, Glossy Black	\$ 1,229
PDRKIT36MB	Color Door Kit, Matte Black	\$ 1,229
FMSBEZKIT11-BR	Large Bezel Kit for 36" Ranges, Venetian Brass	\$ 539
FMSBEZKIT11-BZ	Large Bezel Kit for 36" Ranges, Brushed Bronze	\$ 539
FMSBEZKIT11-MB	Large Bezel Kit for 36" Ranges, Matte Black	\$ 539
F6BG36STD	36" Back Guard, Standard 3" Trim	\$ 219
F6BG36HBT	36" Back Guard, 9" Highback Trim	\$ 359
F6BG36BCI	36" Back Guard, Cast Iron Island Trim	\$ 139
FMWOK	Wok Ring	\$ 69
FMSIM	Simmer Plate	\$ 89
FMGRID36	Griddle, 36"	\$ 219
FMTRP36	Telescopic Rack, 36" Range	\$ 249
FMHAK36	High Altitude Kit, 36" Range	\$ 59

Inventory levels are subject to change, check stock via Dealer Login on www.pinnaclesalesgroup.com

SOFIA Professional Freestanding 600



SOFIA FREESTANDING RANGES - DUAL FUEL

F6PDF486GS1

48" Dual Fuel Professional Range
Series: 600
AVAILABLE IN 7 FINISHES



RANGES

Cooking Surface

- 3 Heavy Duty, Continuous Cast Iron Grates
- Trilaminar Stainless Steel Griddle with Tubular Gas Burner
- Griddle Performs at 11,500 BTUs on High and 2,000 BTUs on Low
- One Piece, Matte Finish Porcelain Burner Bowl
- 6 Dual-Flame Crescendo Burners
- 2 Burners Provide Maximum 20,000 BTUs of Power
- 4 Burners Provide Maximum 18,000 BTUs of Power
- Simmer Setting adjustable to 375 BTUs
- Standard Natural Gas, LP Conversion Kit Included
- Cast Iron Island Trim

Oven

- Dual True Convection in Main Oven
- True Convection in Accessory Oven
- Self-Cleaning Ovens with Multifunction Baking
- Black Porcelain Enamel Interior
- Cool to Touch, Soft-Closing Door
- Extra Large Baking Cavity
- 3 Halogen Lights on Main Oven
- 1 Halogen Light on Accessory Oven
- 4.4 CuFt on Main Oven, 2.7 CuFt on Accessory Oven
- 2 Chrome Racks / 1 Telescopic Rack Per Oven
- Meat Probe (Main Oven)
- Complimentary Personalized Nameplate
- "Sabbath Mode"

Product Information

MODEL	WIDTH	FINISH	DESCRIPTION	UMRP
F6PDF486GS1	48"	Stainless Steel	Dual Fuel Professional Range	\$ 12,499

Optional Accessories

MODEL	DESCRIPTION	UMRP
PDRKIT48MG	Color Two Door Kit, Matte Slate Gray	\$ 1,919
PDRKIT48WH	Color Two Door Kit, Glossy White	\$ 1,919
PDRKIT48MW	Color Two Door Kit, Matte White	\$ 1,919
PDRKIT48RD	Color Two Door Kit, Glossy Red	\$ 1,919
PDRKIT48BK	Color Two Door Kit, Glossy Black	\$ 1,919
PDRKIT48MB	Color Two Door Kit, Matte Black	\$ 1,919
FMSBEZKIT11-BR	Large Bezel Kit for 48" Ranges, Venetian Brass	\$ 539
FMSBEZKIT11-BZ	Large Bezel Kit for 48" Ranges, Brushed Bronze	\$ 539
FMSBEZKIT11-MB	Large Bezel Kit for 48" Ranges, Matte Black	\$ 539
F6BG48STD	Back Guard, 48", 3" Stainless Steel Trim*	\$ 239
F6BG30STD	Back Guard, 30", 3" Standard Trim*	\$ 229
F6BG48BCI	Back Guard, 48", Standard Cast Iron Island Trim*	\$ 229
F6BG48HBT	Back Guard, 48", 9" High Back Trim*	\$ 409
FMWOK	Wok Ring	\$ 69
FMSIM	Simmer Plate	\$ 89
FMTRP30	Telescopic Rack, 30" Main Oven	\$ 229
FMTRP18	Telescopic Rack, 18" Accessory Oven	\$ 219
FMHAK48	High Altitude Kit, 48" Range	\$ 69

Inventory levels are subject to change, check stock via Dealer Login on www.pinnaclesalesgroup.com

SOFIA FREESTANDING RANGES - ALL GAS

F6PGR304S2

30" All Gas Professional Range
Series: 600
AVAILABLE IN 7 FINISHES



SO FIA
Professional 600
Freestanding



Cooking Surface

- 2 Heavy Duty, Continuous Cast Iron Grates
- One Piece Matte Finish Porcelain Burner Bowl
- 4 Dual-Flame Crescendo Burners
- 1 Burner Provides Maximum 20,000 BTUs of Power
- 3 Burners Provide Maximum 18,000 BTUs of Power
- Standard Natural Gas, LP Conversion Kit Included
- Simmer Setting adjustable to 375 BTUs
- Cast Iron Island Trim

Oven

- Dual Convection
- Nova Broiler System
- Black Porcelain Enamel Interior
- Cool to Touch, Soft Closing Door
- Extra Large Baking Cavity
- 3 Halogen Lights for Flawless Visibility
- Glow Plug Ignition
- 4.4 cu. ft. Capacity
- 2 Chrome Racks
- 1 Telescopic Rack
- Enameled Broiler Pan
- Complimentary Personalized Nameplate
- Oven Temperature Electronic Control
- "Sabbath Mode"



Product Information

MODEL	WIDTH	FINISH	DESCRIPTION	UMRP
F6PGR304S2	30"	Stainless Steel	All Gas Professional Range	\$ 5,799

Optional Accessories

MODEL	DESCRIPTION	UMRP
PDRKIT30MG	Color Door Kit, Matte Slate Gray	\$ 1,119
PDRKIT30WH	Color Door Kit, Glossy White	\$ 1,119
PDRKIT30MW	Color Door Kit, Matte White	\$ 1,119
PDRKIT30RD	Color Door Kit, Glossy Red	\$ 1,119
PDRKIT30BK	Color Door Kit, Glossy Black	\$ 1,119
PDRKIT30MB	Color Door Kit, Matte Black	\$ 1,119
FMSBEZKIT06-BR	Small Bezel Kit for 30" Ranges, Venetian Brass	\$ 429
FMSBEZKIT06-BZ	Small Bezel Kit for 30" Ranges, Brushed Bronze	\$ 429
FMSBEZKIT06-MB	Small Bezel Kit for 30" Ranges, Matte Black	\$ 429
F6BG30ISL	30" Back Guard, Island Trim	\$ 149
F6BG30STD	30" Back Guard, Standard 3" Trim	\$ 229
F6BG30HBT	30" Back Guard, 9" Highback Trim	\$ 319
F6BG30BCI	30" Back Guard, Cast Iron Island Trim	\$ 159
FMWOK	Wok Ring	\$ 69
FMSIM	Simmer Plate	\$ 89
FMGRID30	Griddle, 30"	\$ 239
FMTRP30	Telescopic Rack, 30" Range	\$ 229
FMHAK30	High Altitude Kit, 30" Range	\$ 59

Inventory levels are subject to change, check stock via Dealer Login on www.pinnaclesalesgroup.com

STOCK ITEMS ARE LISTED IN RED

SOFIA FREESTANDING RANGES - ALL GAS

SOFIA
Professional 600
Freestanding

F6PGR366S2 / F6PGR364GS2



36" All Gas Professional Range

Series: 600

AVAILABLE IN 7 FINISHES

Cooking Surface

- 3 Heavy Duty, Continuous Cast Iron Grates -OR- 2 Heavy Duty, Continuous Cast Iron Grates with Trilaminate Stainless Steel Griddle w/ Tubular Burner
- One Piece Matte Finish Porcelain Burner Bowl
- 4-6 Dual-Flame Crescendo Burners
- 2 Burners Provide Maximum 20,000 BTUs of Power
- 2-4 Burners Provide Maximum 18,000 BTUs of Power
- Simmer Setting adjustable to 375 BTUs
- Standard Natural Gas, LP Conversion Kit Included
- Cast Iron Island Trim

Oven

- Dual Convection
- Nova Broiler System
- Black Porcelain Enamel Interior
- Cool to Touch, Soft Closing Door
- Extra Large Baking Cavity
- 3 Halogen Lights for Flawless Visibility
- Glow Plug Ignition
- 5.7 cu. ft. Capacity
- 2 Chrome Racks
- 1 Telescopic Rack
- Enameled Broiler Pan
- Complimentary Personalized Nameplate
- Oven Temperature Electronic Control
- "Sabbath Mode"



RANGES



Product Information

MODEL	WIDTH	FINISH	DESCRIPTION	UMRP
F6PGR366S2	36"	Stainless Steel	All Gas Professional Range	\$ 6,999
F6PGR364GS2	36"	Stainless Steel	All Gas Professional Range with Griddle	\$ 7,799

Optional Accessories

MODEL	DESCRIPTION	UMRP
PDRKIT36MG	Color Door Kit, Matte Slate Gray	\$ 1,229
PDRKIT36WH	Color Door Kit, Glossy White	\$ 1,229
PDRKIT36MW	Color Door Kit, Matte White	\$ 1,229
PDRKIT36RD	Color Door Kit, Glossy Red	\$ 1,229
PDRKIT36BK	Color Door Kit, Glossy Black	\$ 1,229
PDRKIT36MB	Color Door Kit, Matte Black	\$ 1,229
FMSBEZKIT11-BR	Large Bezel Kit for 36" Ranges, Venetian Brass	\$ 539
FMSBEZKIT11-BZ	Large Bezel Kit for 36" Ranges, Brushed Bronze	\$ 539
FMSBEZKIT11-MB	Large Bezel Kit for 36" Ranges, Matte Black	\$ 539
F6BG36ISL	36" Back Guard, Island Trim	\$ 159
F6BG36STD	36" Back Guard, Standard 3" Trim	\$ 219
F6BG36HBT	36" Back Guard, 9" Highback Trim	\$ 359
F6BG36BCI	36" Back Guard, Cast Iron Island Trim	\$ 139
FMWOK	Wok Ring	\$ 69
FMSIM	Simmer Plate	\$ 89
FMGRID36	Griddle, 36"	\$ 219
FMTRP36	Telescopic Rack, 36" Range	\$ 249
FMHAK36	High Altitude Kit, 36" Range	\$ 59

Inventory levels are subject to change, check stock via Dealer Login on www.pinnaclesalesgroup.com

SOFIA FREESTANDING RANGES - ALL GAS

SOFIA
Professional 600
Freestanding



F6PGR486GS2

48" All Gas Professional Range
Series: 600
AVAILABLE IN 7 FINISHES



Cooking Surface

- 3 Heavy Duty, Continuous Cast Iron Grates
- Trilaminate Stainless Steel Griddle with Tubular Gas Burner
- Griddle Performs at 11,500 BTUs on High and 2,000 BTUs on Low
- One Piece, Matte Finish Porcelain Burner Bowl
- 6 Dual-Flame Crescendo Burners
- 2 Burners Provide Maximum 20,000 BTUs of Power
- 4 Burners Provide Maximum 18,000 BTUs of Power
- Simmer Setting adjustable to 375 BTUs
- Standard Natural Gas, LP Conversion Kit Included
- Cast Iron Island Trim

Oven

- Dual Convection in Main Oven
- Nova Broiler System
- Single Convection in Accessory Oven
- Black Porcelain Enamel Interior
- Cool to Touch, Soft-Closing Door
- Extra Large Baking Cavity
- Glow Plug Ignition
- 3 Halogen Lights on Main Oven
- 2 Halogen Lights on Accessory Oven
- 4.4 CuFt on Main Oven, 2.7 CuFt on Accessory Oven
- 2 Chrome Racks / 1 Telescopic Rack per oven
- Complimentary Personalized Nameplate
- "Sabbath Mode"

Product Information

MODEL	WIDTH	FINISH	DESCRIPTION	UMRP
F6PGR486GS2	48"	Stainless Steel	All Gas Professional Range	\$ 11,299

Optional Accessories

MODEL	DESCRIPTION	UMRP
PDRKIT48MG	Color Two Door Kit, Matte Slate Gray	\$ 1,919
PDRKIT48WH	Color Two Door Kit, Glossy White	\$ 1,919
PDRKIT48MW	Color Two Door Kit, Matte White	\$ 1,919
PDRKIT48RD	Color Two Door Kit, Glossy Red	\$ 1,919
PDRKIT48BK	Color Two Door Kit, Glossy Black	\$ 1,919
PDRKIT48MB	Color Two Door Kit, Matte Black	\$ 1,919
FMSBEZKIT11-BR	Large Bezel Kit for 48" Ranges, Venetian Brass	\$ 539
FMSBEZKIT11-BZ	Large Bezel Kit for 48" Ranges, Brushed Bronze	\$ 539
FMSBEZKIT11-MB	Large Bezel Kit for 48" Ranges, Matte Black	\$ 539
F6BG48STD	48" Back Guard, Standard 3" Trim	\$ 239
F6BG48HBT	48" Back Guard, 9" Highback Trim	\$ 409
F6BG48BCI	48" Back Guard, Cast Iron Island Trim	\$ 229
FMWOK	Wok Ring	\$ 69
FMSIM	Simmer Plate	\$ 89
FMTRP30	Telescopic Rack, 30" Main Oven	\$ 229
FMTRP18	Telescopic Rack, 18" Accessory Oven	\$ 219
FMHAK48	High Altitude Kit, 48" Range	\$ 69

Inventory levels are subject to change, check stock via Dealer Login on www.pinnaclesalesgroup.com

STOCK ITEMS ARE LISTED IN RED

SOFIA FREESTANDING RANGES - INDUCTION

RANGES

F6PIR304S1

30" Induction Professional Range
Series: 600
AVAILABLE IN 7 FINISHES



SOFIA
Professional 600
Freestanding



Cooking Surface

- 4 Single Induction Cooking Zones
- Elegant Ceramic Glass Surface
- Premium Induction Technology for Unsurpassed Performance
- Booster Function for Each Cooking Zone
- Residual Heat and Power-On Indicators
- Melting and Simmering Functions
- Pot Detection
- Child Lock Function
- Knob Controlled
- Digital Display Timer
- Stainless Steel Island Trim

Oven

- Dual True Convection
- Self-Cleaning Oven with Multifunction Baking
- Black Porcelain Enamel Interior
- Cool to Touch, Soft-Closing Door
- Extra Large Baking Cavity
- 3 Halogen Lights for Flawless Visibility
- 4.4 cu. ft. Capacity
- 2 Chrome Racks
- 1 Telescopic Rack
- Enameled Broiler Pan
- Meat Probe
- Complimentary Personalized Nameplate
- "Sabbath Mode"



Glossy White

Glossy Black

Slate Gray

Glossy Red

Matte Black

Matte White

Product Information

MODEL	WIDTH	FINISH	DESCRIPTION	UMRP
F6PIR304S1	30"	Stainless Steel	Induction Professional Range	\$ 6,999

Optional Accessories

MODEL	DESCRIPTION	UMRP
PDRKIT30MG	Color Door Kit, Matte Slate Gray	\$ 1,119
PDRKIT30WH	Color Door Kit, Glossy White	\$ 1,119
PDRKIT30MW	Color Door Kit, Matte White	\$ 1,119
PDRKIT30RD	Color Door Kit, Glossy Red	\$ 1,119
PDRKIT30BK	Color Door Kit, Glossy Black	\$ 1,119
PDRKIT30MB	Color Door Kit, Matte Black	\$ 1,119
FMSBEZKIT06-BR	Small Bezel Kit for 30" Ranges, Venetian Brass	\$ 429
FMSBEZKIT06-BZ	Small Bezel Kit for 30" Ranges, Brushed Bronze	\$ 429
FMSBEZKIT06-MB	Small Bezel Kit for 30" Ranges, Matte Black	\$ 429
F6BG30STD	Back Guard, 30", 3" Standard Trim*	\$ 229
F6BG30HBT	Back Guard, 30", 9" High Back Trim*	\$ 319
FMTRP30	Telescopic Rack, 30" Sofia Range	\$ 229

*Range includes a Stainless Steel island trim.

Inventory levels are subject to change, check stock via Dealer Login on www.pinnaclesalesgroup.com

SOFIA FREESTANDING RANGES - INDUCTION

RANGES

SOFA Professional 600 Freestanding



F6PIR365S1

36" Induction Professional Range
Series: 600
AVAILABLE IN 7 FINISHES



Cooking Surface

- 4 Single Induction Cooking Zones
- 1 Dual Max Power 11" Cooking Zone
- Elegant Ceramic Glass Surface
- Premium Induction Technology for Unsurpassed Performance
- Booster Function for Each Cooking Zone
- Residual Heat and Power-On Indicators
- Melting and Simmering Functions
- Pot Detection
- Child Lock Function
- Knob Controlled
- Digital Display Timer
- Stainless Steel Island Trim

Oven

- Dual True Convection
- Self-Cleaning Oven with Multifunction Baking
- Black Porcelain Enamel Interior
- Cool to Touch, Soft-Closing Door
- Extra Large Baking Cavity
- 3 Halogen Lights for Flawless Visibility
- 5.7 cu. ft. Capacity
- 2 Chrome Racks
- 1 Telescopic Rack
- Enameled Broiler Pan
- Meat Probe
- Complimentary Personalized Nameplate
- "Sabbath Mode"



Glossy White

Glossy Black

Slate Gray

Glossy Red

Matte Black

Matte White

Product Information

MODEL	WIDTH	FINISH	DESCRIPTION	UMRP
F6PIR365S1	36"	Stainless Steel	Induction Professional Range	\$ 9,499

Optional Accessories

MODEL	DESCRIPTION	UMRP
PDRKIT36MG	Color Door Kit, Matte Slate Gray	\$ 1,229
PDRKIT36WH	Color Door Kit, Glossy White	\$ 1,229
PDRKIT36MW	Color Door Kit, Matte White	\$ 1,229
PDRKIT36RD	Color Door Kit, Glossy Red	\$ 1,229
PDRKIT36BK	Color Door Kit, Glossy Black	\$ 1,229
PDRKIT36MB	Color Door Kit, Matte Black	\$ 1,229
FMSBEZKIT11-BR	Large Bezel Kit for 36" Ranges, Venetian Brass	\$ 539
FMSBEZKIT11-BZ	Large Bezel Kit for 36" Ranges, Brushed Bronze	\$ 539
FMSBEZKIT11-MB	Large Bezel Kit for 36" Ranges, Matte Black	\$ 539
F6BG36STD	Back Guard, 36", 3" Standard Trim*	\$ 219
F6BG36HBT	Back Guard, 36", 9" High Back Trim*	\$ 359
FMTRP36	Telescopic Rack, 36" Sofia Range	\$ 249

*Range includes a Stainless Steel island trim.

Inventory levels are subject to change, check stock via Dealer Login on www.pinnaclesalesgroup.com

STOCK ITEMS ARE LISTED IN RED

SOFIA Professional 600 Freestanding



Glossy White Glossy Black Slate Gray Glossy Red Matte Black Matte White

SOFIA FREESTANDING RANGES - INDUCTION

F6PIR487S1 / F6PIR485GS1

48" Induction Professional Range

Series: 600

AVAILABLE IN 7 FINISHES



Cooking Surface

- 4 Single Induction Cooking Zones
- 1 Dual Max Power 11" Cooking Zone
- Elegant Ceramic Glass Surface
- 2 Bridge Zone Elements (griddle function or Built-In Griddle)
- Booster Function for Each Cooking Zone
- Residual Heat and Power-On Indicators
- Melting and Simmering Functions
- Pot Detection
- Child Lock Function
- Knob Controlled
- Digital Display Timer
- Stainless Steel Island Trim

Oven

- Dual True Convection in Main Oven
- True Convection in Accessory Oven
- Self-Cleaning Ovens with Multifunction Baking
- Black Porcelain Enamel Interior
- Cool to Touch, Soft-Closing Door
- Extra Large Baking Cavity
- 3 Halogen Lights on Main Oven
- 1 Halogen Light on Accessory Oven
- 4.4 CuFt on Main Oven, 2.7 CuFt on Accessory Oven
- 2 Chrome Racks / 1 Telescopic Rack Per Oven
- Meat Probe (Main Oven)
- Complimentary Personalized Nameplate
- "Sabbath Mode"

Product Information

MODEL	WIDTH	FINISH	DESCRIPTION	UMRP
F6PIR487S1	48"	Stainless Steel	Induction Professional Range	\$ 14,499
F6PIR485GS1	48"	Stainless Steel	Induction Professional Range With Built-in Griddle	\$ 15,499

Optional Accessories

MODEL	DESCRIPTION	UMRP
PDRKIT48MG	Color Two Door Kit, Matte Slate Gray	\$ 1,919
PDRKIT48WH	Color Two Door Kit, Glossy White	\$ 1,919
PDRKIT48MW	Color Two Door Kit, Matte White	\$ 1,919
PDRKIT48RD	Color Two Door Kit, Glossy Red	\$ 1,919
PDRKIT48BK	Color Two Door Kit, Glossy Black	\$ 1,919
PDRKIT48MB	Color Two Door Kit, Matte Black	\$ 1,919
FMSBEZKIT11-BR	Large Bezel Kit for 48" Ranges, Venetian Brass	\$ 539
FMSBEZKIT11-BZ	Large Bezel Kit for 48" Ranges, Brushed Bronze	\$ 539
FMSBEZKIT11-MB	Large Bezel Kit for 48" Ranges, Matte Black	\$ 539
F6BG48STD	Back Guard, 48", 3" Stainless Steel Trim*	\$ 239
F6BG48BCI	Back Guard, 48", Standard Cast Iron Island Trim*	\$ 229
F6BG48HBT	Back Guard, 48", 9" High Back Trim*	\$ 409
FMTRP30	Telescopic Rack, 30" Main Oven	\$ 229
FMTRP18	Telescopic Rack, 18" Accessory Oven	\$ 219

Inventory levels are subject to change, check stock via Dealer Login on www.pinnaclesalesgroup.com

ACCENTO FREESTANDING RANGES - DUAL FUEL

ACCENTO Professional 400 Freestanding



F4PDF304S1

30" Dual Fuel Professional Range

Series: 400

AVAILABLE IN 4 FINISHES



Cooking Surface

- 2 Heavy Duty, Continuous Cast Iron Grates
- One Piece Matte Finish Porcelain Burner Bowl
- 2 Dual-Flame 18,000 BTUs Crescendo Burners
- 2 15,000 BTUs Rapid Burners
- Standard Natural Gas, LP Conversion Kit Included
- Simmer Setting Adjustable to 375 BTUs
- Cast Iron Island Trim

Oven

- Dual True Convection
- Self Cleaning Oven with Multifunctioning Baking
- Black Porcelain Enamel Interior
- Cool to Touch Door
- Extra Large Baking Cavity
- 3 Halogen Lights for Flawless Visibility
- 4.4 cu. ft. Capacity
- 2 Chrome Racks
- Enameled Broiler Pan



Product Information

MODEL	WIDTH	FINISH	DESCRIPTION	PROMO MAP	UMRP
F4PDF304S1	30"	Stainless Steel	Dual Fuel Professional Range	\$ 3,499	\$ 4,549

Optional Accessories

MODEL	DESCRIPTION	UMRP
ACDKIT30MW	30" Accento Color Door Kit, Matte White	\$ 939
ACDKIT30RD	30" Accento Color Door Kit, Glossy Red	\$ 939
ACDKIT30MB	30" Accento Color Door Kit, Matte Black	\$ 939
F6BG30ISL	30" Back Guard, Island Trim	\$ 149
F6BG30STD	30" Back Guard, Standard 3" Trim	\$ 229
F6BG30HBT	30" Back Guard, 9" Highback Trim	\$ 319
F6BG30BCI	30" Back Guard, Cast Iron Island Trim	\$ 159
FMWOK	Wok Ring (For use with dual burner only)	\$ 69
FMSIM	Simmer Plate	\$ 89
FMGRID30	Griddle, 30"	\$ 239
FMTRP30	Telescopic Rack, 30" Range	\$ 229
FMHAK30	High Altitude Kit, 30" Range	\$ 59

*Range includes a cast iron island trim.

Inventory levels are subject to change, check stock via Dealer Login on www.pinnaclesalesgroup.com

STOCK ITEMS ARE LISTED IN RED

ACCENTO FREESTANDING RANGES - DUAL FUEL

ACCENTO Professional 400 Freestanding 400



F4PDF366S1

36" Dual Fuel Professional Range

Series: 400

AVAILABLE IN 4 FINISHES



Cooking Surface

- 3 Heavy Duty, Continuous Cast Iron Grates
- One Piece Matte Finish Porcelain Burner Bowl
- 3 Dual-Flame 18,000 BTUs Crescendo Burners
- 3 15,000 BTUs Rapid Burners
- Standard Natural Gas, LP Conversion Kit Included
- Simmer Setting Adjustable to 375 BTUs
- Cast Iron Island Trim

Oven

- Dual True Convection
- Self Cleaning Oven with Multifunctioning Baking
- Black Porcelain Enamel Interior
- Cool to Touch Door
- Extra Large Baking Cavity
- 3 Halogen Lights for Flawless Visibility
- 5.7 cu. ft. Capacity
- 2 Chrome Racks
- Enameled Broiler Pan



Product Information

MODEL	WIDTH	FINISH	DESCRIPTION	PROMO MAP	UMRP
F4PDF366S1	36"	Stainless Steel	Dual Fuel Professional Range	\$ 3,999	\$ 5,399

Optional Accessories

MODEL	DESCRIPTION	UMRP
ACDKIT36MW	36" Accento Color Door Kit, Matte White	\$ 1,049
ACDKIT36RD	36" Accento Color Door Kit, Glossy Red	\$ 1,049
ACDKIT36MB	36" Accento Color Door Kit, Matte Black	\$ 1,049
F6BG36ISL	36" Back Guard, Island Trim	\$ 159
F6BG36STD	36" Back Guard, Standard 3" Trim	\$ 219
F6BG36HBT	36" Back Guard, 9" Highback Trim	\$ 359
F6BG36BCI	36" Back Guard, Cast Iron Island Trim	\$ 139
FMWOK	Wok Ring (For use with dual burner only)	\$ 69
FMSIM	Simmer Plate	\$ 89
FMGRID36	Griddle, 36"	\$ 219
FMTRP36	Telescopic Rack, 36" Range	\$ 249
FMHAK36	High Altitude Kit, 36" Range	\$ 59

*Range includes a cast iron island trim.

Inventory levels are subject to change, check stock via Dealer Login on www.pinnaclesalesgroup.com

RANGES

ACCENTO FREESTANDING RANGES - ALL GAS

RANGES

ACCENTO
Professional 400
Freestanding



F4PGR304S2

30" All Gas Professional Range

Series: 400

AVAILABLE IN 4 FINISHES



Cooking Surface

- 2 Heavy Duty, Continuous Cast Iron Grates
- One Piece Matte Finish Porcelain Burner Bowl
- 2 Dual-Flame 18,000 BTUs Crescendo Burners
- 2 15,000 BTUs Rapid Burners
- Standard Natural Gas, LP Conversion Kit Included
- Simmer Setting Adjustable to 375 BTUs
- Cast Iron Island Trim

Oven

- Silent Glow Plug Oven Ignition
- Dual Convection
- Black Porcelain Enamel Interior
- Cool to Touch Door
- Extra Large Baking Cavity
- 3 Halogen Lights for Flawless Visibility
- 4.4 cu. ft. Capacity
- 2 Chrome Racks
- Enameled Broiler Pan



Matte White

Glossy Red

Matte Black

Product Information

MODEL	WIDTH	FINISH	DESCRIPTION	PROMO MAP	UMRP
F4PGR304S2	30"	Stainless Steel	All Gas Professional Range	\$ 3,299	\$ 4,449

Optional Accessories

MODEL	DESCRIPTION	UMRP
ACDKIT30MW	30" Accento Color Door Kit, Matte White	\$ 939
ACDKIT30RD	30" Accento Color Door Kit, Glossy Red	\$ 939
ACDKIT30MB	30" Accento Color Door Kit, Matte Black	\$ 939
F6BG30ISL	30" Back Guard, Island Trim	\$ 149
F6BG30STD	30" Back Guard, Standard 3" Trim	\$ 229
F6BG30HBT	30" Back Guard, 9" Highback Trim	\$ 319
F6BG30BCI	30" Back Guard, Cast Iron Island Trim	\$ 159
FMWOK	Wok Ring (For use with dual burner only)	\$ 69
FMSIM	Simmer Plate	\$ 89
FMGRID30	Griddle, 30"	\$ 239
FMTRP30	Telescopic Rack, 30" Range	\$ 229
FMHAK30	High Altitude Kit, 30" Range	\$ 59

*Range includes a cast iron island trim.

Inventory levels are subject to change, check stock via Dealer Login on www.pinnaclesalesgroup.com

ACCENTO FREESTANDING RANGES - ALL GAS

ACCENTO
Professional 400
Freestanding



F4PGR366S2

36" All Gas Professional Range

Series: 400

AVAILABLE IN 4 FINISHES



RANGES

Cooking Surface

- 3 Heavy Duty, Continuous Cast Iron Grates
- One Piece Matte Finish Porcelain Burner Bowl
- 3 Dual-Flame 18,000 BTUs Crescendo Burners
- 3 15,000 BTUs Rapid Burners
- Standard Natural Gas, LP Conversion Kit Included
- Simmer Setting Adjustable to 375 BTUs
- Cast Iron Island Trim

Oven

- Silent Glow Plug Oven Ignition
- Dual Convection
- Black Porcelain Enamel Interior
- Cool to Touch Door
- Extra Large Baking Cavity
- 3 Halogen Lights for Flawless Visibility
- 5.7 cu. ft. Capacity
- 2 Chrome Racks
- Enameled Broiler Pan



Matte White

Glossy Red

Matte Black

Product Information

MODEL	WIDTH	FINISH	DESCRIPTION	PROMO MAP	UMRP
F4PGR366S2	36"	Stainless Steel	All Gas Professional Range	\$ 3,999	\$ 5,249

Optional Accessories

MODEL	DESCRIPTION	UMRP
ACDKIT36MW	36" Accento Color Door Kit, Matte White	\$ 1,049
ACDKIT36RD	36" Accento Color Door Kit, Glossy Red	\$ 1,049
ACDKIT36MB	36" Accento Color Door Kit, Matte Black	\$ 1,049
F6BG36ISL	36" Back Guard, Island Trim	\$ 159
F6BG36STD	36" Back Guard, Standard 3" Trim	\$ 219
F6BG36HBT	36" Back Guard, 9" Highback Trim	\$ 359
F6BG36BCI	36" Back Guard, Cast Iron Island Trim	\$ 139
FMWOK	Wok Ring (For use with dual burner only)	\$ 69
FMSIM	Simmer Plate	\$ 89
FMGRID36	Griddle, 36"	\$ 219
FMTRP36	Telescopic Rack, 36" Range	\$ 249
FMHAK36	High Altitude Kit, 36" Range	\$ 59

*Range includes a cast iron island trim.

Inventory levels are subject to change, check stock via Dealer Login on www.pinnaclesalesgroup.com



RANGETOPS

SOFIA
Professional 600
Rangetops

F6GRT304S1

30" Gas Professional Rangetop
Series: 600



Features

- 2 Heavy Duty, Continuous Cast Iron Grates
- One Piece, Matte Finish Porcelain Burner Bowl
- 4 Dual-Flame Crescendo Burners
- 1 Burner Provides Maximum 20,000 BTUs of Power
- 3 Burners Provide Maximum 18,000 BTUs of Power
- Simmer Setting adjustable to 375 BTUs
- Standard Natural Gas, LP Conversion Kit Included
- Electronic Re-Ignition System
- Flame-out Sensor
- Top Mount Injector
- Cast Iron Island Trim

Product Information

MODEL	WIDTH	FINISH	DESCRIPTION	UMRP
F6GRT304S1	30"	Stainless Steel	All Gas Professional Rangetop	\$ 2,999

Optional Accessories

MODEL	DESCRIPTION	UMRP
F6BG30ISL	30" Back Guard, Island Trim	\$ 149
F6BG30STD	30" Back Guard, Standard 3" Trim	\$ 229
F6BG30HBT	30" Back Guard, 9" Highback Trim	\$ 319
F6BG30BCI	30" Back Guard, Cast Iron Island Trim	\$ 159
FMSBEZKIT06-BR	Small Bezel Kit for 30" Rangetops, Venetian Brass	\$ 429
FMSBEZKIT06-BZ	Small Bezel Kit for 30" Rangetops, Brushed Bronze	\$ 429
FMSBEZKIT06-MB	Small Bezel Kit for 30" Rangetops, Matte Black	\$ 429
FMWOK	Wok Ring	\$ 69
FMSIM	Simmer Plate	\$ 89
FMGRID30	Griddle, 30"	\$ 239

Inventory levels are subject to change, check stock via Dealer Login on www.pinnaclesalesgroup.com

SOFIA RANGETOPS - GAS

SOFIA
Professional 600
Rangetops

F6GRT366S1 / F6GRT364GS1

36" Gas Professional Rangetop
Series: 600



Features

- 3 Heavy Duty, Continuous Cast Iron Grates -OR- 2 Heavy Duty, Continuous Cast Iron Grates with Trilaminate Stainless Steel Griddle w/ Tubular Burner
- One Piece Matte Finish Porcelain Burner Bowl
- 4-6 Dual-Flame Crescendo Burners
- 2 Burners Provide Maximum 20,000 BTUs of Power
- 2-4 Burners Provide Maximum 18,000 BTUs of Power
- Simmer Setting adjustable to 375 BTUs
- Standard Natural Gas, LP Conversion Kit Included
- Cast Iron Island Trim

Product Information

MODEL	WIDTH	FINISH	DESCRIPTION	UMRP
F6GRT366S1	36"	Stainless Steel	All Gas Professional Rangetop	\$ 3,599
F6GRT364GS1	36"	Stainless Steel	All Gas Professional Rangetop With Built-In Griddle	\$ 4,699

Optional Accessories

MODEL	DESCRIPTION	UMRP
F6BG36ISL	36" Back Guard, Island Trim	\$ 159
F6BG36STD	36" Back Guard, Standard 3" Trim	\$ 219
F6BG36HBT	36" Back Guard, 9" Highback Trim	\$ 359
F6BG36BCI	36" Back Guard, Cast Iron Island Trim	\$ 139
FMSBEZKIT11-BR	Small Bezel Kit for 36" Rangetops, Venetian Brass	\$ 539
FMSBEZKIT11-BZ	Small Bezel Kit for 36" Rangetops, Brushed Bronze	\$ 539
FMSBEZKIT11-MB	Small Bezel Kit for 36" Rangetops, Matte Black	\$ 539
FMWOK	Wok Ring	\$ 69
FMSIM	Simmer Plate	\$ 89
FMGRID36	Griddle, 36"	\$ 219

Inventory levels are subject to change, check stock via Dealer Login on www.pinnaclesalesgroup.com

SOFIA Professional 600 Rangetops

F6GRT486GS1

48" Gas Professional Rangetop
Series: 600



Features

- 3 Heavy Duty, Continuous Cast Iron Grates
- Trilaminar Stainless Steel Griddle with Tubular Gas Burner
- Griddle Performs at 11,500 BTUs on High and 2,000 BTUs on Lows
- One Piece Matte Finish Porcelain Burner Bowl
- 6 Dual-Flame Crescendo Burners
- 2 Burners Provide Maximum 20,000 BTUs of Power
- 4 Burners Provide Maximum 18,000 BTUs of Power
- Simmer Setting Adjustable to 375 BTUs
- Standard Natural Gas, LP Conversion Kit Included
- Electronic Re-Ignition System
- Flame-Out Sensor
- Top Mount Injectors
- Cast Iron Island Trim

Product Information

MODEL	WIDTH	FINISH	DESCRIPTION	UMRP
F6GRT486GS1	48"	Stainless Steel	All Gas Professional Rangetop	\$ 5,599

Optional Accessories

MODEL	DESCRIPTION	UMRP
F6BG48STD	Back Guard, 48", 3" Stainless Steel Trim*	\$ 239
F6BG30STD	Back Guard, 30", 3" Standard Trim*	\$ 229
F6BG48BCI	Back Guard, 48", Standard Cast Iron Island Trim*	\$ 229
F6BG48HBT	Back Guard, 48", 9" High Back Trim*	\$ 409
FMSBEZKIT11-BR	Large Bezel Kit for 48" Rangetops, Venetian Brass	\$ 539
FMSBEZKIT11-BZ	Large Bezel Kit for 48" Rangetops, Brushed Bronze	\$ 539
FMSBEZKIT11-MB	Large Bezel Kit for 48" Rangetops, Matte Black	\$ 539
FMWOK	Wok Ring	\$ 69
FMSIM	Simmer Plate	\$ 89

Inventory levels are subject to change, check stock via Dealer Login on www.pinnaclesalesgroup.com

SOFIA RANGETOPS - INDUCTION

RANGE TOPS

SOFIA
Professional 600
Rangetops

F6IRT304S1

30" Professional Induction Rangetop
Series: 600



Features

- 4 Single Induction Cooking Zones
- Elegant Ceramic Glass Surface
- Premium Induction Technology for Unsurpassed Performance
- Boost Function for Each Cooking Zone
- Automatic Heat-Up Time
- Residual Heat and Power On Indicators
- Melting and Simmering Functions
- Pot Detection System
- Child Lock Function
- Digital Power Level Display
- Stainless Steel Island Trim
- Knob Controlled

Product Information

MODEL	WIDTH	FINISH	DESCRIPTION	UMRP
F6IRT304S1	30"	Stainless Steel	Induction Professional Rangetop	\$ 3,499

Optional Accessories

MODEL	DESCRIPTION	UMRP
F6BG30STD	Back Guard, 30", 3" Standard Trim*	\$ 229
F6BG30BCI	Back Guard, 30", Cast Iron Island Trim*	\$ 159
F6BG30HBT	Back Guard, 30", 9" High Back Trim*	\$ 319
FMSBEZKIT06-BR	Small Bezel Kit for 30" Rangetops, Venetian Brass	\$ 429
FMSBEZKIT06-BZ	Small Bezel Kit for 30" Rangetops, Brushed Bronze	\$ 429
FMSBEZKIT06-MB	Small Bezel Kit for 30" Rangetops, Matte Black	\$ 429

*Rangetop includes a stainless steel island trim.

Inventory levels are subject to change, check stock via Dealer Login on www.pinnaclesalesgroup.com

SOFIA RANGETOPS - INDUCTION

SOFIA
Professional 600
Rangetops

F6IRT365S1

36" Professional Induction Rangetop
Series: 600



RANGE TOPS



Features

- 4 Single Induction Cooking Zones
- 1 Dual Max Power with 11" Cooking Zone
- Elegant Ceramic Glass Surface
- Premium Induction Technology for Unsurpassed Performance
- Boost Function for Each Cooking Zone
- Automatic Heat-Up Time
- Residual Heat and Power On Indicators
- Melting and Simmering Functions
- Pot Detection System
- Child Lock Function
- Digital Power Level Display
- Stainless Steel Island Trim
- Knob Controlled

Product Information

MODEL	WIDTH	FINISH	DESCRIPTION	UMRP
F6IRT365S1	36"	Stainless Steel	Induction Professional Rangetop	\$ 4,799

Optional Accessories

MODEL	DESCRIPTION	UMRP
F6BG36STD	Back Guard, 36", 3" Standard Stainless Steel Trim*	\$ 219
F6BG36BCI	Back Guard, 36", Cast Iron Trim*	\$ 139
F6BG36HBT	Back Guard, 36", 9" High Back Trim*	\$ 359
FMSBEZKIT11-BR	Small Bezel Kit for 36" Rangetops, Venetian Brass	\$ 539
FMSBEZKIT11-BZ	Small Bezel Kit for 36" Rangetops, Brushed Bronze	\$ 539
FMSBEZKIT11-MB	Small Bezel Kit for 36" Rangetops, Matte Black	\$ 539

* Range includes a Stainless Steel island trim.

Inventory levels are subject to change, check stock via Dealer Login on www.pinnaclesalesgroup.com

SOFIA RANGETOPS - INDUCTION

RANGE TOPS

SOFIA
Professional 600
Rangetops

F6IRT487S1 / F6IRT485GS1
48" Professional Induction Rangetop
Series: 600



Features

- 4 Single Induction Cooking Zones
- 1 Dual Max Power 11" Cooking Zone
- Elegant Ceramic Glass Surface
- 2 Bridge Zone Elements (griddle function or Built-In Griddle)
- Booster Function for Each Cooking Zone
- Residual Heat and Power-On Indicators
- Melting and Simmering Functions
- Pot Detection
- Child Lock Function
- Knob Controlled
- Digital Display Timer
- Stainless Steel Island Trim

Product Information

MODEL	WIDTH	FINISH	DESCRIPTION	UMRP
F6IRT487S1	48"	Stainless Steel	Induction Professional Rangetop	\$ 7,799
F6IRT485GS1	48"	Stainless Steel	Induction Professional Rangetop With Built-in Griddle	\$ 8,999

Optional Accessories

MODEL	DESCRIPTION	UMRP
F6BG48STD	Back Guard, 48", 3" Stainless Steel Trim*	\$ 239
F6BG48BCI	Back Guard, 48", Standard Cast Iron Trim*	\$ 229
F6BG48HBT	Back Guard, 48", 9" High Back Trim*	\$ 409
FMSBEZKIT11-BR	Large Bezel Kit for 48" Rangetopss, Venetian Brass	\$ 539
FMSBEZKIT11-BZ	Large Bezel Kit for 48" Rangetops, Brushed Bronze	\$ 539
FMSBEZKIT11-MB	Large Bezel Kit for 48" Rangetops, Matte Black	\$ 539

Inventory levels are subject to change, check stock via Dealer Login on www.pinnaclesalesgroup.com



COOKTOPS

SOFIA COOKTOPS - GAS

COOKTOPS

SOFIA
Professional Cooktops 600

F6PGK305S2

30" Gas Professional Cooktop
Series: 600



Featuring
Backlit
Control Knobs
and Brass
Burners



Features

- 3 Heavy Duty Continuous Cast Iron Grates
- Heavy Gauge 304 Stainless Steel Burner Bowl
- 1 Solid Brass Dual Flame Burner with 20,000 BTUs
- 2 Solid Brass Rapid Burners with 10,500 BTUs Each
- 2 Solid Brass Semi-Rapid Burners with 8,000 BTUs Each
- Backlit Control Knob Indicates Burner Operation (White)
- Backlit Control Knob Indicates Residual Heat (Red)
- Heavy Duty Control Panel
- Large Cooking Area
- Full Pot Stability
- Standard Natural Gas, LP Conversion Kit Included

Product Information

MODEL	WIDTH	FINISH	DESCRIPTION	UMRP
F6PGK305S2	30"	Stainless Steel	All Gas Professional Cooktop	\$ 1,899

Optional Accessories

MODEL	DESCRIPTION	UMRP
FMWOK	Wok Ring (For use with dual burner only)	\$ 69
FMSIM	Simmer Plate	\$ 89

Inventory levels are subject to change, check stock via Dealer Login on www.pinnaclesalesgroup.com

SOFIA
Professional 600
Cooktops

F6PGK365S1

36" Gas Professional Cooktop
Series: 600



Featuring
Backlit
Control Knobs
and Brass
Burners

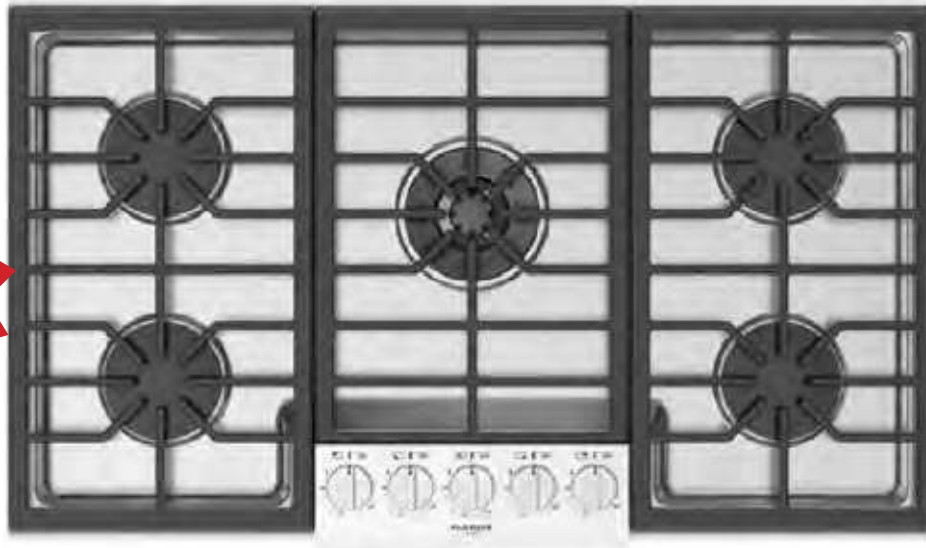

Features

- 3 Heavy Duty Continuous Cast Iron Grates
- Heavy Gauge 304 Stainless Steel Burner Bowl
- 1 Solid Brass Dual Flame Burner with 20,000 BTUs
- 4 Solid Brass Stacked Burners with 15,000 BTUs Each
- Backlit Control Knob Indicates Burner Operation (White)
- Backlit Control Knob Indicates Residual Heat (Red)
- Heavy Duty Control Panel
- Large Cooking Area
- Full Pot Stability
- Standard Natural Gas, LP Conversion Kit Included

Product Information

MODEL	WIDTH	FINISH	DESCRIPTION	UMRP
F6PGK365S1	36"	Stainless Steel	All Gas Professional Cooktop	\$ 2,249

Optional Accessories

MODEL	DESCRIPTION	UMRP
FMWOK	Wok Ring (For use with dual burner only)	\$ 69
FMSIM	Simmer Plate	\$ 89

Inventory levels are subject to change, check stock via Dealer Login on www.pinnaclesalesgroup.com

SOFIA COOKTOPS - GAS

COOKTOPS

SOFIA
Professional 400
Cooktops

F4PGK305S2

30" Gas Professional Cooktop
Series: 400



Features

- 3 Heavy Duty Continuous Cast Iron Grates
- Heavy Gauge 304 Stainless Steel Burner Bowl
- 1 Aluminum Dual Flame Burner with 20,000 BTUs
- 2 Aluminum Rapid Burners with 8,000 BTUs Each
- 2 Aluminum Semi-Rapid Burners with 6,300 BTUs Each
- Heavy Duty Control Panel
- Large Cooking Area
- Full Pot Stability
- Standard Natural Gas, LP Conversion Kit Included

Product Information

MODEL	WIDTH	FINISH	DESCRIPTION	UMRP
F4PGK305S2	30"	Stainless Steel	All Gas Professional Cooktop	\$ 1,549

Optional Accessories

MODEL	DESCRIPTION	UMRP
FMWOK	Wok Ring (For use with dual burner only)	\$ 69
FMSIM	Simmer Plate	\$ 89

Inventory levels are subject to change, check stock via Dealer Login on www.pinnaclesalesgroup.com

SOFIA
Professional 400
Cooktops

F4PGK365S1

36" Gas Professional Cooktop
Series: 400



Features

- 3 Heavy Duty Continuous Cast Iron Grates
- Heavy Gauge 304 Stainless Steel Burner Bowl
- 1 Aluminum Dual Flame Burner with 20,000 BTUs
- 2 Aluminum Stacked Burners with 15,000 BTUs Each
- 1 Aluminum Stacked Burner with 12,000 BTUs
- 1 Aluminum Stacked Burner with 8,000 BTUs
- Heavy Duty Control Panel
- Large Cooking Area
- Full Pot Stability
- Standard Natural Gas, LP Conversion Kit Included

Product Information

MODEL	WIDTH	FINISH	DESCRIPTION	UMRP
F4PGK365S1	36"	Stainless Steel	All Gas Professional Cooktop	\$ 1,999

Optional Accessories

MODEL	DESCRIPTION	UMRP
FMWOK	Wok Ring (For use with dual burner only)	\$ 69
FMSIM	Simmer Plate	\$ 89

Inventory levels are subject to change, check stock via Dealer Login on www.pinnaclesalesgroup.com

MATTEO COLLECTION COOKTOPS - GAS

MATTEO
Series 400
Gas Cooktops

F4MGK24S1 / F4MGK24MB1
24" Gas Cooktop
Matteo Series: 400



COOKTOPS

NEW



NEW



Features

- 4 Brass Burners (3 Sealed Burners and a Powerful Dual Flame Burner)
- 1 Dual Flame Burner with 20,000 BTUs
- Electric Re-Ignition System
- Flame-Out Sensor
- Heavy Duty Cast Iron Grates
- Available in Matte Black or Stainless Steel

Product Information

	MODEL	WIDTH	FINISH	DESCRIPTION	UMRP
NEW	F4MGK24S1	24"	Stainless Steel	Gas Cooktop w/ 4 Brass Burners	\$ 1,079
NEW	F4MGK24MB1	24"	Matte Black	Gas Cooktop w/ 4 Brass Burners	\$ 1,099

Optional Accessories

MODEL	DESCRIPTION	UMRP
FMSPR	Small Pot Insert/Reducer, Single Burner	\$ 69
FMWOK	Wok Ring (For use with dual burner only)	\$ 69
FMSIM	Simmer Plate, Single Burner	\$ 89

Inventory levels are subject to change, check stock via Dealer Login on www.pinnaclesalesgroup.com

MATTEO COLLECTION COOKTOPS - GAS

MATTEO
Series 400
Gas Cooktops

F4MGK30S1 / F4MGK30MB1

30" Gas Cooktop
Matteo Series: 400



COOKTOPS

NEW



NEW



Features

- 5 Brass Burners (4 Sealed Burners and a Powerful Dual Flame Burner)
- 1 Dual Flame Burner with 20,000 BTUs
- Electric Re-Ignition System
- Flame-Out Sensor
- Heavy Duty Cast Iron Grates
- Available in Matte Black or Stainless Steel

Product Information

	MODEL	WIDTH	FINISH	DESCRIPTION	UMRP
NEW	F4MGK30S1	30"	Stainless Steel	Gas Cooktop w/ 5 Brass Burners & Wok	\$ 1,279
NEW	F4MGK30MB1	30"	Matte Black	Gas Cooktop w/ 5 Brass Burners & Wok	\$ 1,299

Optional Accessories

MODEL	DESCRIPTION	UMRP
FMSPR	Small Pot Insert/Reducer, Single Burner	\$ 69
FMWOK	Wok Ring (For use with dual burner only)	\$ 69
FMSIM	Simmer Plate, Single Burner	\$ 89

Inventory levels are subject to change, check stock via Dealer Login on www.pinnaclesalesgroup.com

MATTEO COLLECTION COOKTOPS - GAS

MATTEO
Series 400
Gas Cooktops

F4MTGK36S1 / F4MTGK36MB1

36" Gas Cooktop
Matteo Series: 400



COOKTOPS

NEW



NEW



Features

- 5 Brass Burners (4 Sealed Burners and a Powerful Dual Flame Burner)
- 1 Dual Flame Burner with 20,000 BTUs
- Electric Re-Ignition System
- Flame-Out Sensor
- Heavy Duty Cast Iron Grates
- Available in Matte Black or Stainless Steel

Product Information

	MODEL	WIDTH	FINISH	DESCRIPTION	UMRP
NEW	F4MTGK36S1	36"	Stainless Steel	Gas Cooktop w/ 5 Brass Burners	\$ 1,349
NEW	F4MTGK36MB1	36"	Matte Black	Gas Cooktop w/ 5 Brass Burners	\$ 1,399

Optional Accessories

MODEL	DESCRIPTION	UMRP
FMSPR	Small Pot Insert/Reducer, Single Burner	\$ 69
FMWOK	Wok Ring (For use with dual burner only)	\$ 69
FMSIM	Simmer Plate, Single Burner	\$ 89

Inventory levels are subject to change, check stock via Dealer Login on www.pinnaclesalesgroup.com

STOCK ITEMS ARE LISTED IN RED

MATTEO COLLECTION COOKTOPS - GAS

MATTEO
Series 400
Gas Cooktops

F4MEGK36S1 / F4MEGK36MB1

36" Gas Cooktop
Matteo Series: 400



COOKTOPS

NEW



NEW



Features

- 5 Brass Burners (4 Sealed Burners and a Powerful Dual Flame Burner)
- 1 Dual Flame Burner with 20,000 BTUs
- Electric Re-Ignition System
- Flame-Out Sensor
- Heavy Duty Cast Iron Grates
- Available in Matte Black or Stainless Steel

Product Information

	MODEL	WIDTH	FINISH	DESCRIPTION	UMRP
NEW	F4MEGK36S1	36"	Stainless Steel	Gas Cooktop w/ 5 Brass Burners & Wok	\$ 1,349
NEW	F4MEGK36MB1	36"	Matte Black	Gas Cooktop w/ 5 Brass Burners & Wok	\$ 1,399

Optional Accessories

MODEL	DESCRIPTION	UMRP
FMSPR	Small Pot Insert/Reducer, Single Burner	\$ 69
FMWOK	Wok Ring (For use with dual burner only)	\$ 69
FMSIM	Simmer Plate, Single Burner	\$ 89

Inventory levels are subject to change, check stock via Dealer Login on www.pinnaclesalesgroup.com

SOFIA COLLECTION COOKTOPS - INDUCTION

COOKTOPS

Series 700
Induction Cooktops

F7IT30S1 & F7IT36S1

30" & 36" Induction Cooktop
Series: 700



F7IT30S1



F7IT36S1

Features

- 4 Cooking Zones - 30"
- 5 Cooking Zones - 36"
- Bridge Zone - 36"
- Easy Clean Textured Ceramic Glass Surface
- 11" Cooking Zone
- Premium Induction Technology for Unsurpassed Performance
- Independent Timer for Each Zone
- Melting and Warming Functions
- Residual Heat and Power on Indicators
- Pan and Pot Detection System
- Child Lock Function
- Booster Function for each Cooking Zone
- Digital Display for Power Level
- Elegant Aluminum Trim
- Pause Function
- Automatic Fast-Boil Function

Product Information

MODEL	WIDTH	FINISH	DESCRIPTION	UMRP
F7IT30S1	30"	Black Glass	Induction Cooktop	\$ 1,949
F7IT36S1	36"	Black Glass	Induction Cooktop	\$ 2,549

Inventory levels are subject to change, check stock via Dealer Login on www.pinnaclesalesgroup.com

Series 400
Induction Cooktops

F4IT24B2 & F4IT24S2

24" Induction Cooktop
Series: 400

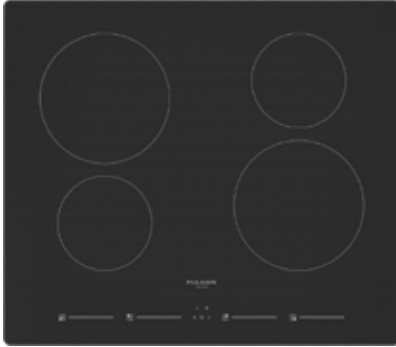

F4IT24B2

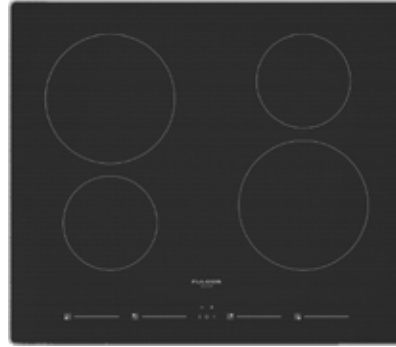

F4IT24S2

Features

- 4 Cooking Zones
- Easy Clean Textured Ceramic Glass Surface
- Independent Timer for Each Zone
- Melting and Warming Functions
- Residual Heat and Power on Indicators
- Pan and Pot Detection System
- Child Lock Function
- Booster Function for each Cooking Zone
- Digital Display for Power Level
- Elegant Aluminum Trim
- Pause Function

Product Information

MODEL	WIDTH	FINISH	DESCRIPTION	UMRP
F4IT24B2	24"	Black Glass	Induction Cooktop	\$ 1,279
F4IT24S2	24"	Black Glass w/ Aluminum Trim	Induction Cooktop	\$ 1,349

Inventory levels are subject to change, check stock via Dealer Login on www.pinnaclesalesgroup.com

COOKTOPS - INDUCTION

COOKTOPS

Series 400
Induction Cooktops

F4IT30B2 & F4IT30S2

30" Induction Cooktop
Series: 400

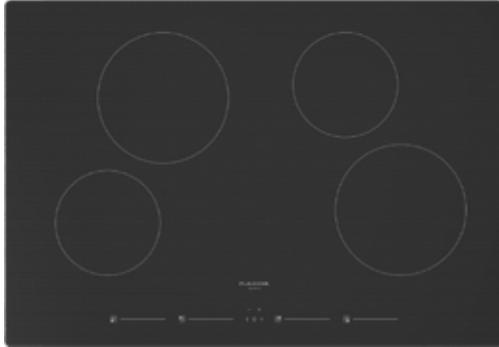

F4IT30B2

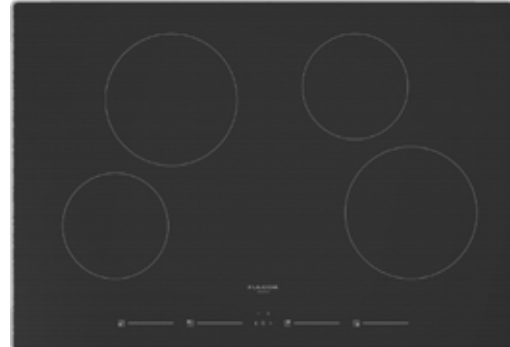

F4IT30S2

Features

- 4 Cooking Zones
- Easy Clean Textured Ceramic Glass Surface
- Built-In Timer
- Melting Functions
- Residual Heat and Power on Indicators
- Pan and Pot Detection System
- Child Lock Function
- Booster Function for each Cooking Zone
- Digital Display for Power Level
- Elegant Aluminum Trim
- Pause Function
- Automatic Fast-Boil Function

Product Information

MODEL	WIDTH	FINISH	DESCRIPTION	UMRP
F4IT30B2	30"	Black Glass	Induction Cooktop	\$ 1,379
F4IT30S2	30"	Black Glass w/ Aluminum Trim	Induction Cooktop	\$ 1,449

Inventory levels are subject to change, check stock via Dealer Login on www.pinnaclesalesgroup.com

Series 700
Radiant Cooktops

F7RT24 & F7RT30
24" & 30" Radiant Cooktop
Series: 700



F7RT24B1



F7RT30S1

Features

- 4 Cooking Zones - 30"
- 5 Cooking Zones - 36"
- Bridge Zone - 36"
- Digital Display for Power Level
- Low Power Scale for Delicate Cooking
- Control Lock
- Automatic Fast-Boil Function
- Independent Timer for Each Zone
- Easy Clean Textured Glass Surface
- Power and Hot Surface Indication
- Timer Functions
- Timer Display
- Acoustic Buzzer
- Brushed Aluminum Trim
- Booster Function for Each Cooking Zone

Product Information

MODEL	WIDTH	FINISH	DESCRIPTION	UMRP
F7RT24B1	24"	Black Glass	Radiant Cooktop	\$ 979
F7RT24S1	24"	Black Glass w/ Aluminum Trim	Radiant Cooktop	\$ 999
F7RT30B1	30"	Black Glass	Radiant Cooktop	\$ 1,099
F7RT30S1	30"	Black Glass w/ Aluminum Trim	Radiant Cooktop	\$ 1,149

Inventory levels are subject to change, check stock via Dealer Login on www.pinnaclesalesgroup.com

COOKTOPS - RADIANT

COOKTOPS

Series 300
Radiant Cooktops

F3RK24S2
24" Radiant Cooktop
Series: 300

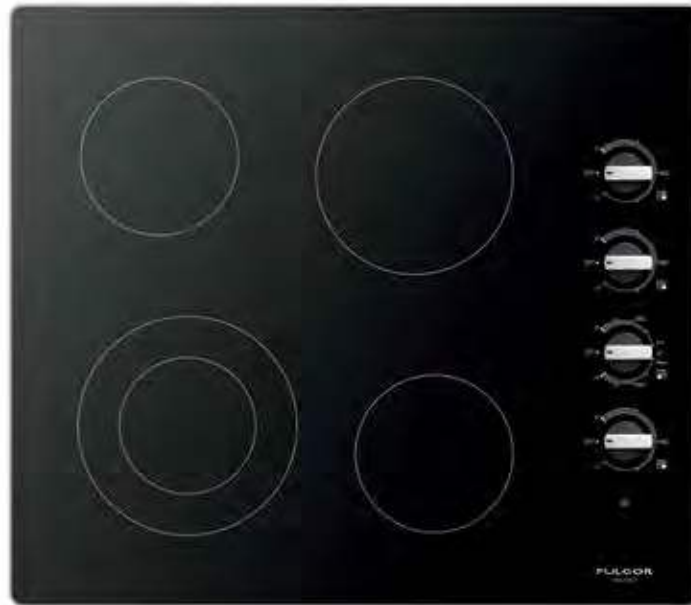

Features

- 4 Cooking Zones
- Power on Indication
- Hot Surface Indication
- Easy Clean Ceramic Glass
- Residual Heat Sensor
- Double Radiant Cooking Zone
- Brushed Aluminum Trim

Product Information

MODEL	WIDTH	FINISH	DESCRIPTION	UMRP
F3RK24S2	24"	Black Glass w/ Aluminum Trim	Radiant Cooktop	\$ 919

Inventory levels are subject to change, check stock via Dealer Login on www.pinnaclesalesgroup.com



OVENS

SOFIA BUILT-IN OVENS - SINGLE

SOFIA
Professional 600
Single Oven

F6PSP30S1

30" Professional Single Oven
Series: 600
Available in 7 Finishes



OVENS

Features

- Knob and Electronic Controls
- Dual True Convection
- Self-Cleaning Oven with Multi-function Baking
- Black Porcelain Enamel Interior
- Cool to Touch, Soft-Closing Door
- Extra-Large Baking Cavity and Viewing Area
- 3 Halogen Lights for Flawless Visibility
- Gross Capacity 4.4 cu. ft.
- 2 Chrome Racks
- 1 Telescopic Rack
- Enameled Broiler Pan
- Complimentary Personalized Nameplate
- Perfect for Installation Under a Cooktop

Oven Functions

- Bake
- Broil
- Roast
- Sabbath Mode
- Electronic Cooking Programmer
- True Convection
- Warm / Proof / Dehydrate / Defrost
- Timer Controlled Cooking
- Meat Probe
- Self Clean
- Bake
- Convection

Product Information

MODEL	WIDTH	FINISH	DESCRIPTION	UMRP
F6PSP30S1	30"	Stainless Steel	Professional Single Oven	\$ 4,199

Optional Accessories

MODEL	DESCRIPTION	UMRP
PDRKIT30MG	Color Door Kit, Matte Slate Gray	\$ 1,119
PDRKIT30WH	Color Door Kit, Glossy White	\$ 1,119
PDRKIT30MW	Color Door Kit, Matte White	\$ 1,119
PDRKIT30RD	Color Door Kit, Glossy Red	\$ 1,119
PDRKIT30BK	Color Door Kit, Glossy Black	\$ 1,119
PDRKIT30MB	Color Door Kit, Matte Black	\$ 1,119
FMSBEZKIT06-BR	Small Bezel Kit for Wall Ovens, Venetian Brass	\$ 429
FMSBEZKIT06-BZ	Small Bezel Kit for Wall Ovens, Brushed Bronze	\$ 429
FMSBEZKIT06-MB	Small Bezel Kit for Wall Ovens, Matte Black	\$ 429
FMTRP30	Telescopic Rack, 30"	\$ 229

Line drawing found on page 84

Inventory levels are subject to change, check stock via Dealer Login on www.pinnaclesalesgroup.com

STOCK ITEMS ARE LISTED IN RED

SOFIA BUILT-IN OVENS - DOUBLE

SOFIA Professional Double Oven 600



F6PDP30S1

30" Professional Double Oven
Series: 600
Available in 7 Finishes



OVENS

Features

- Knob and Electronic Controls
- Dual True Convection
- Self-Cleaning Oven with Multi-Function Baking
- Black Porcelain Enamel Interior
- Cool to Touch, Soft Closing Door
- Extra-Large Baking Cavity and Viewing Area
- 3 Halogen Lights for Flawless Visibility
- Gross Capacity 4.4 cu. ft. Per Oven
- 2 Chrome Racks Per Oven
- 1 Telescopic Rack Per Oven
- Enameled Broiler Pan
- Complimentary Personalized Nameplate (Bottom Oven Only)

Oven Functions

- Bake
- Broil
- Roast
- Convection
- True Convection
- Warm / Proof / Dehydrate / Defrost
- Timer Controlled Cooking
- Meat Probe (Top Oven)
- Self Clean
- Sabbath Mode
- Electronic Cooking Programmer

Product Information

MODEL	WIDTH	FINISH	DESCRIPTION	UMRP
F6PDP30S1	30"	Stainless Steel	Professional Double Oven	\$ 6,999

Optional Accessories

MODEL	DESCRIPTION	UMRP
F6PDPKIT30MG	Double Wall Oven Color Kit, 2 Doors, Matte Slate Gray	\$ 2,188
F6PDPKIT30WH	Double Wall Oven Color Kit, 2 Doors, Glossy White	\$ 2,188
F6PDPKIT30MW	Double Wall Oven Color Kit, 2 Doors, Matte White	\$ 2,188
F6PDPKIT30RD	Double Wall Oven Color Kit, 2 Doors, Glossy Red	\$ 2,188
F6PDPKIT30BK	Double Wall Oven Color Kit, 2 Doors, Glossy Black	\$ 2,188
F6PDPKIT30MB	Double Wall Oven Color Kit, 2 Doors, Matte Black	\$ 2,188
FMSBEZKIT06-BR	Small Bezel Kit for Wall Ovens, Venetian Brass	\$ 429
FMSBEZKIT06-BZ	Small Bezel Kit for Wall Ovens, Brushed Bronze	\$ 429
FMSBEZKIT06-MB	Small Bezel Kit for Wall Ovens, Matte Black	\$ 429
FMTRP30	Telescopic Rack, 30"	\$ 229

Line drawing found on page 85

Inventory levels are subject to change, check stock via Dealer Login on www.pinnaclesalesgroup.com



CREACTIVE

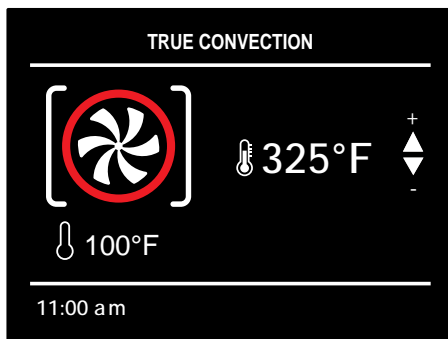

MULTI-LEVEL COOKING MODE
Internal heat remains constant throughout the oven, while smells and flavors are kept apart due to the fan assisted system.

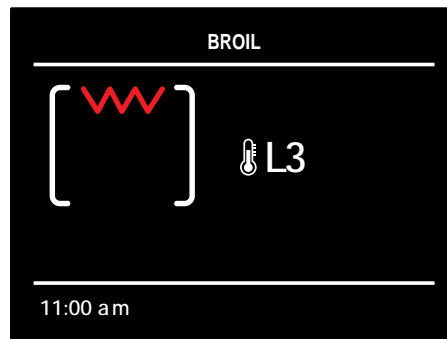

BROIL
The most effective way to brown or roast your meat in a short amount of time.

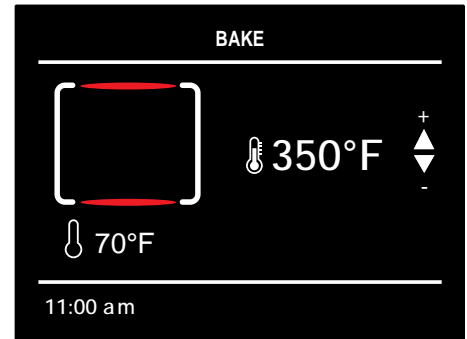

BAKE
Optimal for perfect baking: flavors blend effortlessly.

Creactive Control System

Our Creactive Control System featured on select 700 Series Built-In Wall Ovens and Specialty Ovens combines cutting edge technology with simplicity.

The touch screen simplifies all procedures and improves performance by reducing energy consumption while intensifying cooking modes. The automatic function system has safety features to warn against and prevent possible damages.

TOUCH CONTROL PANEL

Everything is under your control with just one touch on the Creactive display.

INTUITIVE

It only takes a moment to easily find the desired function.

MULTITASKING

All functions help to get the best results while preparing your recipes.



PIZZA MODE 590 °F

Two pizzas can be cooked in only two and a half minutes at the same time with a maximum temperature of 590 °F.



CUSTOMIZABLE RECIPES

Cooking times and modes have been preprogrammed, but you can modify and customize your recipes to suit every palate and need.

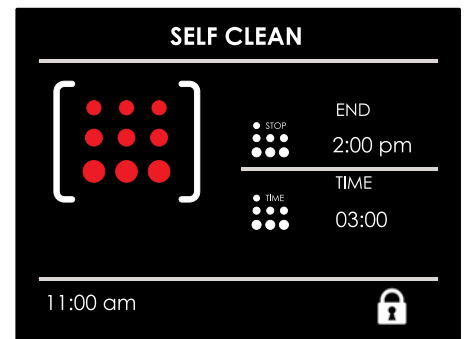

SELF-CLEANING

The pyrolytic self-clean function, selected directly from display, consists of heating the inside of the oven to very high temperatures in order to burn off any excess grease and food residue.

MATTEO COLLECTION BUILT-IN OVENS - SINGLE ELECTRIC

MATTEO
Series 700
Single Ovens

F7MSM24S1 / F7MSM24MB1
24" Easy Clean Single Oven
Matteo Series: 700



OVENS



Features

- Full Touch Controls
- Display TFT 3,5"
- 3 Heat-resistant Glass Panel
- Cool Touch Door
- Soft Closing Door
- Interior Halogen Light
- Preset Default Temperature
- Setting Weight kg/lb
- Display Brightness Setting (ON/OFF Condition)
- Beeper Volume Setting
- Display Control Lock
- Sabbath Mode
- 12/24-Hour Clock Formats
- Automatic Fast Preheat
- Temperature Display °C / °F
- Meat Probe
- Event Log (for Service)

Oven Functions

- True Convection
- Convection Roast
- Convection Broil Roast
- Convection Bake
- Eco Convection
- Eco Broil
- Broil
- Convection Broil
- Upper Bake
- Pizza
- Air Fry
- Easy Clean
- Defrost
- Dehydrate
- Bake
- Roast

Product Information

MODEL	WIDTH	FINISH	DESCRIPTION	UMRP
NEW F7MSM24S1	24"	Stainless Steel	Convection Wall Oven, Easy Clean Oven	\$ 1,549
NEW F7MSM24MB1	24"	Matte Black	Convection Wall Oven, Easy Clean Oven	\$ 1,579

Optional Accessories

MODEL	DESCRIPTION	UMRP
FMTELG	24" Telescopic Oven Rack Guides	\$ 119

Inventory levels are subject to change, check stock via Dealer Login on www.pinnaclesalesgroup.com

STOCK ITEMS ARE LISTED IN RED

MATTEO COLLECTION BUILT-IN OVENS - SINGLE ELECTRIC



MATTEO
Series 700
Single Ovens

F7MSP24S1 / F7MSP24MB1

24" Self Clean Single Oven
Matteo Series: 700



NEW



NEW



OVENS

Features

- Creative Touch Control System
- Self Clean
- True Convection
- Black Porcelain Enamel Interior
- 1 Halogen Light
- Gross Capacity 2.6 CuFt
- 2 Chrome Racks
- 15 Cooking Functions
- Telescopic Rack
- Enameled Broiler Pan
- 1200W Broiler Element (240V)
- Perfect for Installation Under Cooktop
- Cool to Touch Door
- Door Safety Lock
- Fast PreHeat Mode
- Pre-Loaded Recipes that can be Customized
- Sabbath Mode
- Soft Closing Door

Oven Functions

- True Convection
- Convection Roast
- Convection Broil Roast
- Convection Bake
- Eco Convection
- Eco Broil
- Broil
- Convection Broil
- Upper Bake
- Air Fry
- Hydro Clean
- Defrost
- Dehydrate
- Bake
- Roast

Product Information

	MODEL	WIDTH	FINISH	DESCRIPTION	UMRP
NEW	F7MSP24S1	24"	Stainless Steel	Convection Wall Oven, Self Clean Oven	\$ 2,079
NEW	F7MSP24MB1	24"	Matte Black	Convection Wall Oven, Self Clean Oven	\$ 2,099

Optional Accessories

MODEL	DESCRIPTION	UMRP
FMTELG	24" Telescopic Oven Rack Guides	\$ 119

Inventory levels are subject to change, check stock via Dealer Login on www.pinnaclesalesgroup.com

MATTEO COLLECTION BUILT-IN OVENS - SINGLE ELECTRIC



MATTEO
Series 700
Single Ovens

F7MSP30S1 / F7MSP30MB1

30" Self Clean Single Oven
Matteo Series: 700



OVENS

NEW



NEW



Features

- Creative Touch Control System
- Available in Matte Black or Stainless Steel
- Dual True Convection
- Self-Cleaning Oven with Multifunction Baking
- Black Porcelain Enamel Interior
- Cool to Touch Door
- Extra-Large Baking Cavity and Viewing Area
- 3 Halogen Lights for Flawless Visibility
- Total Capacity 4.4 Cu. Ft.
- 2 Chromed Racks, 1 Telescopic Rack
- Enameled Broiler Pan
- Lock Keys
- Door Lock
- Soft Closing Door

Oven Functions

- True Convection
- Defrost
- Dehydrate
- Warm / Proof
- Warm Plus
- Bake
- Roast
- Pizza
- Convection Roast
- Convection Grill
- Convection Bake
- Broil (5 Levels)
- Pizza Pizzeria (Recipes)
- Sabbath
- Air Fry
- Self Clean
- Meat Probe

Product Information

MODEL	WIDTH	FINISH	DESCRIPTION	UMRP
NEW F7MSP30S1	30"	Stainless Steel	Convection Wall Oven, Self Clean Oven	\$ 3,399
NEW F7MSP30MB1	30"	Matte Black	Convection Wall Oven, Self Clean Oven	\$ 3,499

Optional Accessories

MODEL	DESCRIPTION	UMRP
FMTELG	24" Telescopic Oven Rack Guides	\$ 119

Inventory levels are subject to change, check stock via Dealer Login on www.pinnaclesalesgroup.com

STOCK ITEMS ARE LISTED IN RED

MATTEO COLLECTION BUILT-IN OVENS - DOUBLE ELECTRIC

CREACTIVE  **MATTEO**
Series 700
Single Ovens

F7MDP30S1 / F7MDP30MB1

30" Self Clean Double Oven
Matteo Series: 700



NEW



NEW



OVENS

Features

- Creative Touch Control System
- Available in Matte Black or Stainless Steel
- Dual True Convection
- Self-Cleaning Oven with Multifunction Baking
- Black Porcelain Enamel Interior
- Cool to the Touch
- Extra-Large Baking Cavity and Viewing Area
- 3 Halogen Lights for Flawless Visibility
- Total Capacity 4.4 Cu. Ft.
- 2 Chromed Racks, 1 Telescopic Rack Per Oven
- Enameled Broiler Pan
- Lock Keys
- Door Lock
- Soft Closing Door

Oven Functions

- True Convection
- Defrost
- Dehydrate
- Warm / Proof
- Warm Plus
- Bake
- Roast
- Pizza
- Convection Roast
- Convection Grill
- Convection Bake
- Broil (5 Levels)
- Pizza Pizzeria (Recipes)
- Sabbath
- Air Fry
- Self Clean
- Meat Probe (Upper Oven Only)

Product Information

MODEL	WIDTH	FINISH	DESCRIPTION	UMRP
NEW F7MDP30S1	30"	Stainless Steel	Double Convection Wall Oven, Self Clean Oven	\$ 5,799
NEW F7MDP30MB1	30"	Matte Black	Double Convection Wall Oven, Self Clean Oven	\$ 5,899

Optional Accessories

MODEL	DESCRIPTION	UMRP
FMTELG	24" Telescopic Oven Rack Guides	\$ 119

Inventory levels are subject to change, check stock via Dealer Login on www.pinnaclesalesgroup.com

MATTEO COLLECTION BUILT-IN OVENS - SINGLE ELECTRIC

MATTEO
Series 400
Single Ovens

F4MSP30S1

30" Self Clean Single Oven
Matteo Series: 400



OVENS

NEW



Features

- Knob and electronic controls
- Single fan true convection
- Self-cleaning oven with Multifunction baking
- Black Porcelain enamel interior
- Cool to the touch
- Extra-large baking cavity and viewing area
- 3 Halogen lights for flawless visibility
- Total capacity 4,4 cu. ft.
- 2 chrome racks
- Enameled Broiler Pan
- Soft Closing Door

Oven Functions

- Bake
- Broil
- Roast
- Convection
- True Convection
- Dehydrate
- Self-Clean
- Sabbath Mode

Product Information

MODEL	WIDTH	FINISH	DESCRIPTION	UMRP
NEW F4MSP30S1	30"	Stainless Steel	Convection Wall Oven, Self Clean	\$ 2,449

Optional Accessories

MODEL	DESCRIPTION	UMRP
FMTR630	30" Telescopic Oven Guides	\$ 199

Inventory levels are subject to change, check stock via Dealer Login on www.pinnaclesalesgroup.com

STOCK ITEMS ARE LISTED IN RED

MATTEO COLLECTION BUILT-IN OVENS - SINGLE ELECTRIC

MATTEO Series 400 Single Ovens

F1MSM24

24" Self Clean Single Oven
Matteo Series: 400



NEW



NEW



OVENS

Features

- Available in Matte Black or Stainless Steel
- Knob and Electronic Controls
- True Convection
- Black Porcelain Enamel Interior
- 1 Halogen Light
- Total Capacity 2.4 Cu. Ft.
- 2 Chrome Racks
- Enameled Broiler Pan

Oven Functions

- Convection Bake
- Convection Broil
- Convection Roast
- Bake
- Broil

Product Information

	MODEL	WIDTH	FINISH	DESCRIPTION	UMRP
NEW	F1MSM24S1	24"	Stainless Steel	Convection Single Oven, Euro Height, Easy Clean	\$ 949
NEW	F1MSM24MB1	24"	Matte Black	Convection Single Oven, Euro Height, Easy Clean	\$ 999

Optional Accessories

	MODEL	DESCRIPTION	UMRP
	FMTELG	24" Telescopic Oven Rack Guides	\$ 119

Inventory levels are subject to change, check stock via Dealer Login on www.pinnaclesalesgroup.com

MATTEO COLLECTION BUILT-IN OVENS - SINGLE ELECTRIC

MATTEO Series 100
Single Ovens

F1MSM30 / F1MSP30

30" Single Oven
Matteo Series: 100



OVENS



Features

- Available in Matte Black or Stainless Steel
- Knob and Electronic Controls
- Black Porcelain Enamel Interior
- 2 Halogen Lights
- Cool to the Touch
- Total Capacity 3.2 Cu. Ft.
- 2 Chromed Racks
- Enameled Grill Pan
- Easy Clean or Self Clean
- ADA Compliant

Oven Functions

- Bake
- Roast
- True Convection
- Convection Roast
- Broil
- Convection Grill
- Convection Broil
- Pizza
- Pizza Pizzeria (Recipes)
- Defrost
- Dehydrate
- Warm / Proof
- Warm Plus
- Sabbath
- Air Fry
- Self Clean (F1MSP Models Only)

Product Information

MODEL	WIDTH	FINISH	DESCRIPTION	UMRP
NEW F1MSM30S1	30"	Stainless Steel	Convection Single Oven, Euro Height, Easy Clean	\$ 1,699
NEW F1MSM30MB1	30"	Matte Black	Convection Single Oven, Euro Height, Easy Clean	\$ 1,749
NEW F1MSP30S1	30"	Stainless Steel	Convection Single Oven, Euro Height, Self Clean	\$ 1,979
NEW F1MSP30MB1	30"	Matte Black	Convection Single Oven, Euro Height, Self Clean	\$ 1,999

Optional Accessories

MODEL	DESCRIPTION	UMRP
FMTR130	30" Telescopic Oven Rack	\$ 199

Inventory levels are subject to change, check stock via Dealer Login on www.pinnaclesalesgroup.com

STOCK ITEMS ARE LISTED IN RED

SOFIA SPECIALTY OVENS - **SPEED**

SOFIA
Professional 600
Double Oven

F6PSPD30S1

30" Combi Convection Speed Oven

Series: 600

OVENS



Features

- 3-in-1 Combi Oven (Microwave, Convection and Broil)
- 10 Cooking Functions
- Quick access menu
- Automatic programs
- Combined microwave and fan assisted mode
- 240 Volt Connection
- Microwave Mode has 6 Power Levels
- Pre-Loaded recipes that can be Customized
- Defrosting by Time and Weight
- Stainless Steel Interior
- Cool Touch Door
- Interior Lighting
- 1.2 CuFt Capacity

Included

- Meat Probe
- 1 Micro-perforated Pan with Stainless Steel Cover
- 1 Stainless Steel Tray
- 1 Flat Rack

Product Information

MODEL	WIDTH	FINISH	DESCRIPTION	UMRP
F6PSPD30S1	30"	Stainless Steel	Professional Speed Oven	\$ 3,099

Inventory levels are subject to change, check stock via Dealer Login on www.pinnaclesalesgroup.com

MATTEO COLLECTION BUILT-IN OVENS - **SPEED OVEN**

OVENS

 **MATTEO**
Series 700
Single Ovens

F7MSPD24 / F7MSPD30S1
24" & 30" Combi Convection Speed Oven 
Matteo Series: 700



Features

- Available in Matte Black or Stainless Steel
- 3 in 1 Combi Oven: Microwave, Convection, and Broil
- Stainless Interior
- Quick Access Menu
- Single Keyboard
- Automatic Programs
- 240 Volt Connection
- 10 Combined Functions
- Soft Closing Door
- Automatic Cooking
- Pre-Selected and Customizable Recipes (Weight, Temperature, Cooking Time)
- Microwave Mode (6 Levels)
- Fan Assisted Mode
- Combined Cooking Mode
- Microwave and Broil Mode
- Defrosting by Time and Weight
- Air Fry

Oven Functions

- True Convection
- Convection Roast
- Convection Broil
- Broil
- Time Defrost
- Weight Defrost
- Microwave Only
- Microwave Broil
- Microwave Convection

Product Information

	MODEL	WIDTH	FINISH	DESCRIPTION	UMRP
NEW	F7MSPD24S1	24"	Stainless Steel	Combi Convection Speed Oven	\$ 2,449
NEW	F7MSPD24MB1	24"	Matte Black	Combi Convection Speed Oven	\$ 2,499
NEW	F7MSPD30S1	30"	Stainless Steel	Combi Convection Speed Oven	\$ 2,899
NEW	F7MSPD30MB1	30"	Matte Black	Combi Convection Speed Oven	\$ 2,979

Inventory levels are subject to change, check stock via Dealer Login on www.pinnaclesalesgroup.com

STOCK ITEMS ARE LISTED IN RED

SOFIA SPECIALTY OVENS - **STEAM**



SOFIA
Professional **600**
Oven

F6PSCO30S1

30" Combi Convection Steam Oven
Series: 600

OVENS



Features

- 3-in-1 Combi Oven (Steam, Convection and Broil)
- 12 Cooking Functions
- Removable Water Tank
- Quick Access Menu
- 240 Volt Connection
- Pre-Loaded recipes that can be Customized
- Steam Recovery System
- Easy Steam Cleaning Cycle
- Limescale Water Filter
- Stainless Steel Interior
- Cool Touch Door
- Interior Lighting
- 1.2 CuFt Capacity
- Air Fry

Included

- Meat Probe
- 1 Micro-perforated Pan with Stainless Steel Cover
- 1 Stainless Steel Tray
- 1 Flat Rack

Product Information

MODEL	WIDTH	FINISH	DESCRIPTION	UMRP
F6PSCO30S1	30"	Stainless Steel	Professional Steam Oven	\$ 3,449

Inventory levels are subject to change, check stock via Dealer Login on www.pinnaclesalesgroup.com

MATTEO COLLECTION BUILT-IN OVENS - SPEED OVEN

OVENS

 **MATTEO**
Series 700
Single Ovens

F7MSCO24 / F7MSCO30

24" & 30" Combi Convection Steam Oven 
Matteo Series: 700



Features

- 3-in-1 Combi Oven (Steam, Convection and Broil)
- 12 Cooking Functions
- Removable Water Tank
- Quick Access Menu
- 240 Volt Connection
- Pre-Loaded recipes that can be Customized
- Steam Recovery System
- Easy Steam Cleaning Cycle
- Limescale Water Filter
- Stainless Steel Interior
- Cool Touch Door
- Interior Lighting
- 1.2 CuFt Capacity

Included

- Meat Probe
- 1 Micro-perforated Pan with Stainless Steel Cover
- 1 Stainless Steel Tray
- 1 Flat Rack

Oven Functions

- True Convection
- Convection Roast
- Convection Broil
- Broil
- Air Fry
- Steam Cook
- Steam Reheat
- Steam Convection
- Steam Clean
- Clean Steam System

Product Information

	MODEL	WIDTH	FINISH	DESCRIPTION	UMRP
NEW	F7MSCO24S1	24"	Stainless Steel	Combi Convection Steam Oven	\$ 2,749
NEW	F7MSCO24MB1	24"	Matte Black	Combi Convection Steam Oven	\$ 2,779
NEW	F7MSCO30S1	30"	Stainless Steel	Combi Convection Steam Oven	\$ 3,149
NEW	F7MSCO30MB1	30"	Matte Black	Combi Convection Steam Oven	\$ 3,199

Inventory levels are subject to change, check stock via Dealer Login on www.pinnaclesalesgroup.com

STOCK ITEMS ARE LISTED IN RED

MATTEO COLLECTION - WARMING DRAWERS

MATTEO
Series 700
Warming Drawers

F7MWD30 / F4MWD24

24" & 30" Warming Drawer, Push to Open ⚡
Matteo Series: 700

WARMING
DRAWERS



Features

- Available in Matte Black or Stainless Steel
- Knob Control
- Heavy Duty Full Extendable Telescopic Rails
- Large Capacity
2.1 Cu. Ft. - 30"
.5 Cu. Ft. - 24"
- Convection Fan Assisted Heating System for a More Even Heating Distribution
- All Stainless Steel Structure
- Warming Temperature Range: 86 °F - 190 °F
- Push to Open and Close the Door
- 2 Internal Lights
- Non-Slip Rubber Mat

Functions

- Pre-Heat Dishes
- Pre-Heat Coffee Cups
- Keep Warm Ready Food
- Defrosting
- Proofing Dough
- Slow Cooking Min. 86 °F Up to 190 °F

Product Information

	MODEL	WIDTH	Height	FINISH	DESCRIPTION	UMRP
NEW	F7MWD30S1	30"	10"	Stainless Steel	Warming Drawer, Push to Open	\$ 1,449
NEW	F7MWD30MB1	30"	10"	Matte Black	Warming Drawer, Push to Open	\$ 1,479
NEW	F4MWD24S1	24"	6"	Stainless Steel	Warming Drawer, Push to Open	\$ 1,099
NEW	F4MWD24MB1	24"	6"	Matte Black	Warming Drawer, Push to Open	\$ 1,119
	F7IWD30O1	30"	10"	Panel Ready - Push-to-Open	Warming Drawer	\$ 1,349

* Discontinued once inventory levels are depleted

Inventory levels are subject to change, check stock via Dealer Login on www.pinnaclesalesgroup.com

SOFIA PROFESSIONAL WARMING DRAWERS

WARMING DRAWERS

SOFIA
Professional Warming Drawer 600

F6PWD30S1 / F6IWD30O1

30" Professional Warming Drawer

Series: 600

Available in 7 Finishes

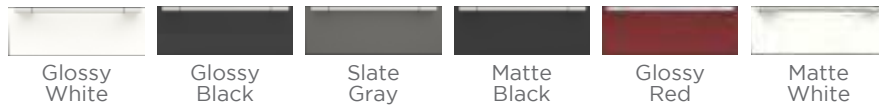

Features

- Stainless Steel Construction
- Knob Control
- Full Extension Telescopic Rails
- Large Capacity, 2.1 CuFt
- Convection Heating System for Even Heat Distribution
- Warming Temperature Range - 86°F - 190°F
- Push-Pull System to Open and Close Door
- Interior Lighting
- Non-Slip Rubber Mat
- Available in Stainless Steel and Panel Ready

Functions

- Pre-heat Dishes
- Pre-heat Coffee Cups
- Keep Food Warm
- Defrosting
- Proofing Dough
- Slow Cooking - 86°F - 190°F

Product Information

MODEL	WIDTH	Height	FINISH	DESCRIPTION	UMRP
F6PWD30S1	30"	10"	Stainless Steel	Professional Warming Drawer	\$ 1,599
NEW F6IWD30O1	30"	10"	Panel Ready	Professional Warming Drawer	\$ 1,349

Optional Accessories for F6PWD30S1 Model Only

MODEL	DESCRIPTION	UMRP
PWDKIT30MG	Color Drawer Kit, Matte Slate Gray	\$ 359
PWDKIT30WH	Color Drawer Kit, Glossy White	\$ 359
PWDKIT30MW	Color Drawer Kit, Matte White	\$ 359
PWDKIT30RD	Color Drawer Kit, Glossy Red	\$ 359
PWDKIT30BK	Color Drawer Kit, Glossy Black	\$ 359
PWDKIT30MB	Color Drawer Kit, Matte Black	\$ 359

Inventory levels are subject to change, check stock via Dealer Login on www.pinnaclesalesgroup.com

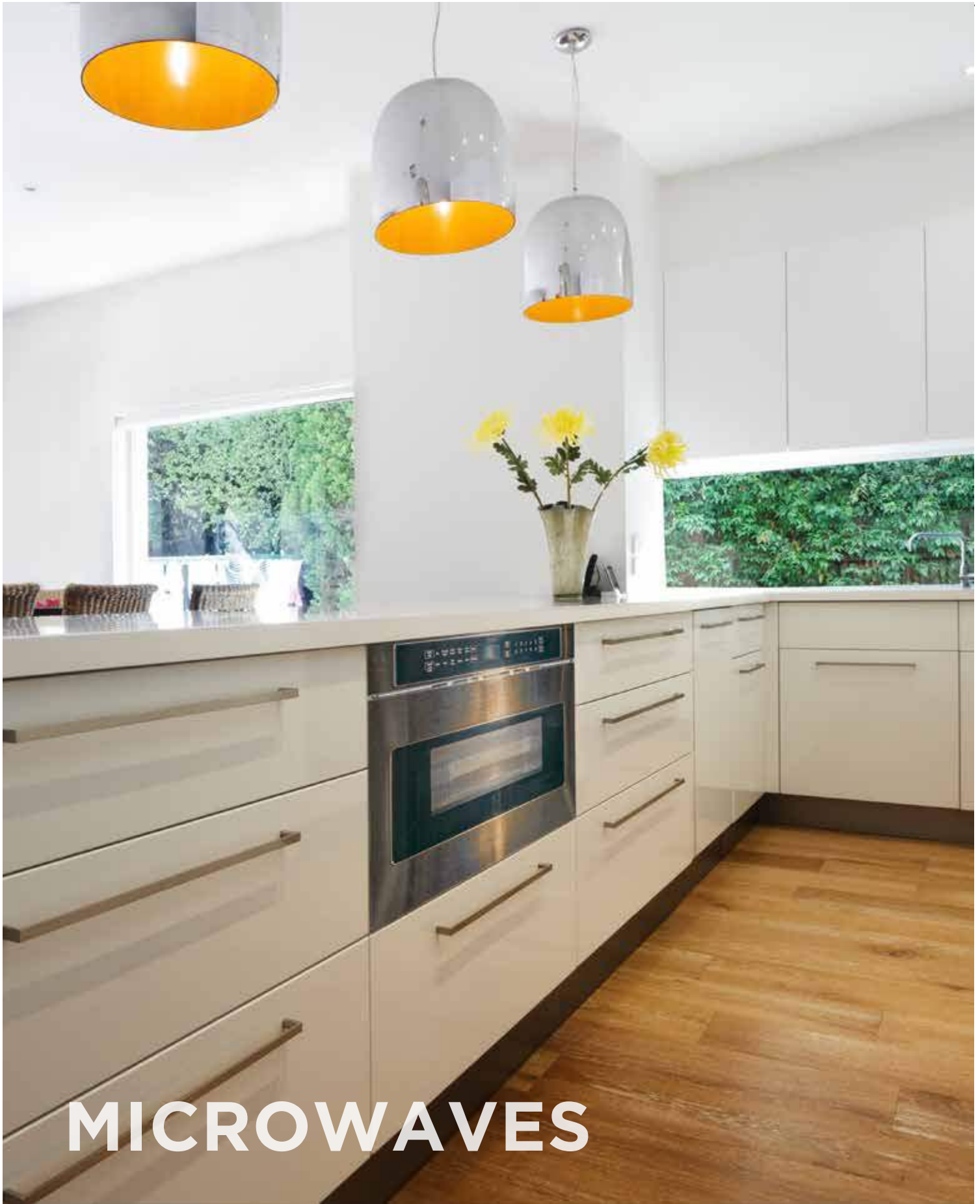

MICROWAVES

COLLECTION MICROWAVE OVENS - DRAWER UNIT

MICROWAVES

Series 700
Microwave Ovens

F7DMW24S2

24" Microwave Oven Drawer Unit
Series: 700



Features

- Stainless Steel Design
- LED Interior Lighting
- Touch Glass Control Panel
- Accessible Height to Easily Remove Hot Food
- Built-In Airflow Control for Flush Installation
- Transparent Glass Door
- 1.2 CuFt Capacity
- 950 Watt Power
- 11 Power Levels
- Flexible Installation

Product Information

MODEL	WIDTH	FINISH	DESCRIPTION	UMRP
F7DMW24S2	24"	Stainless Steel	Microwave Oven Drawer Unit	\$ 1,619

Inventory levels are subject to change, check stock via Dealer Login on www.pinnaclesalesgroup.com

STOCK ITEMS ARE LISTED IN RED

COLLECTION MICROWAVE OVENS - **COUNTERTOP / BUILT-IN**
AVAILABLE Q2 2025

MICROWAVES

F4MWO24S2

24" Countertop or Built-In Microwave Oven
Series: 400



Series 400
Microwave Ovens

Features

- Family Size
- 2.0 CuFt Capacity
- 1100 Watt Power
- 11 Power Levels
- Push Button Opener
- Electronic Touch Control
- Super Defrost
- Sensor Cook Menu
- Auto Start
- Two-Step Child Lock
- 4 Program Stages



Product Information

MODEL	WIDTH	FINISH	DESCRIPTION	UMRP
F4MWO24S2	24"	Stainless Steel	Countertop or Built-In Microwave Oven	\$ 619

Optional Accessories

MODEL	DESCRIPTION	UMRP
F4TK30MWO	30" Stainless Steel Trim Kit for Built-In Installation	\$ 479

Inventory levels are subject to change, check stock via Dealer Login on www.pinnaclesalesgroup.com

COLLECTION MICROWAVE OVENS - OVER THE RANGE

MICROWAVES

Series 400
Microwave Ovens

F4OTR30S1

30" OTR Microwave Oven
Series: 400



Features

- 1.8 CuFt Capacity
- 1100 Watt Power
- 10 Power Levels
- LED Display
- LED Lighting
- Recessed Cavity
- Child-Safe Lock-Out Feature
- Removable Glass Turntable
- 450 CFM
- Ducted or Recirculating Installation
- Charcoal Filter Included

Product Information

MODEL	WIDTH	FINISH	DESCRIPTION	UMRP
F4OTR30S1 *	30"	Stainless Steel	OTR Microwave Oven	\$ 669

* Discontinued once inventory levels are depleted

Inventory levels are subject to change, check stock via Dealer Login on www.pinnaclesalesgroup.com



COFFEE SYSTEMS

BUILT-IN PRODUCTS - COFFEE MACHINE



MATTEO
Series 700
Single Ovens

F7MBC24 / F7BC24B1
24" Built-In Coffee Machine
Matteo Series: 700



NEW



F7MBC24S1

NEW



F7MBC24MB1

Features

- Whole Bean Coffee Grinder
- 13 Brewing Functions
- Touch Control Panel
- Dual Dispensing for 2 Cups
- Adjustable Coffee Strength and Grinder Settings
- Fast 3 Minute Heating
- Auto Start Function
- Automatic Cleaning Cycle
- Included Milk Froth Pitcher
- Removable Water Tank



F7BC24B1
30" TRIM KITS

Function

- 3 Coffee Temperature Settings
- 5 Coffee Strength Settings
- 5 Mug Size Settings
- Steam and Frothing
- Hot Water Dispenser
- Telescopic Easy Clean Access
- Stand-by (Energy Saving) Mode



F7DTK30BC



F6DTK30BC

Safety

- Water hardness setting
- Coffee and water refill indicators
- One Touch Cleaning Cycle
- Limescale Filter
- Empty Coffee Grounds Indicator

Product Information

MODEL	WIDTH	FINISH	DESCRIPTION	UMRP
NEW F7MBC24S1	24"	Stainless Steel	Built-In Fully Automatic Coffee Machine	\$ 3,599
NEW F7MBC24MB1	24"	Matte Black	Built-In Fully Automatic Coffee Machine	\$ 3,649
F7BC24B1	24"	Black Glass	Built-In Coffee Machine	\$ 3,399

Optional Accessories

MODEL	DESCRIPTION	UMRP
NEW F7MTK30BCS	30" Matteo Stainless Steel Trim Kit for Black Glass Unit Only (F7BC24B1 Sold Separately)	\$ 699
NEW F7MTK30BCMB	30" Matteo Matte Black Trim Kit for Black Glass Unit Only (F7BC24B1 Sold Separately)	\$ 719
F6DTK30BC	30" Professional Trim Kit for Black Glass Unit Only (F7BC24B1)	\$ 699

Inventory levels are subject to change, check stock via Dealer Login on www.pinnaclesalesgroup.com



REFRIGERATION

EXPLORE OUR COLUMN REFRIGERATION



Automatic Defrost System

Extra Deep Storage Capacity

Ice Maker with Adjustable Cube Size

Full Extension Bins

Natural wood shelves

Two temperature zones

Available in Stainless Steel
and Panel-Ready options

Zero-Clearance,
Heavy-Duty
Stainless Steel
Hinge System

LED
Lighting

Lateral
Airflow
Curtain

Brilliant White
Aluminum and
Stainless Steel
Interior

Stainless Steel
Soft-Close
Crisper Drawers

Full-Extension Soft
Close Drawers

SOFIA REFRIGERATION - COLUMN REFRIGERATORS

F7SRC / F7IRC

Column Refrigerator

Series: 700

Series 700

Features

- Lateral Airflow Curtain
- Brilliant White Aluminum and Stainless Steel Interior
- Height Adjustable Glass Shelves
- Extra Deep Storage Capacity
- Full Extension Microbeaded Stainless Steel Soft Close Drawers
- Multilevel LED Lighting
- Interior LED Digital Touch Interface
- Super Quiet 41 dB Noise Level
- Available in Stainless Steel and Panel Ready Options
- Stainless Steel Model Ships with Sofia Pro Handle
- Refrigerator Available in Widths: 24", 30" and 36"
- Joining Kit Included with Freezer and Wine Column



Product Information

MODEL	WIDTH	FINISH	DESCRIPTION	UMRP
F7SRC24S1-R	24"	Stainless Steel	Column Refrigerator, RH	\$ 8,999
F7SRC24S1-L	24"	Stainless Steel	Column Refrigerator, LH	\$ 8,999
F7IRC24O1-R	24"	Panel Ready	Column Refrigerator, Panel Ready, RH	\$ 8,799
F7IRC24O1-L	24"	Panel Ready	Column Refrigerator, Panel Ready, LH	\$ 8,799
F7SRC30S1-R	30"	Stainless Steel	Column Refrigerator, RH	\$ 9,299
F7SRC30S1-L	30"	Stainless Steel	Column Refrigerator, LH	\$ 9,299
F7IRC30O1-R	30"	Panel Ready	Column Refrigerator, Panel Ready, RH	\$ 9,099
F7IRC30O1-L	30"	Panel Ready	Column Refrigerator, Panel Ready, LH	\$ 9,099
F7SRC36S1-R	36"	Stainless Steel	Column Refrigerator, RH	\$ 9,599
F7SRC36S1-L	36"	Stainless Steel	Column Refrigerator, LH	\$ 9,599
F7IRC36O1-R	36"	Panel Ready	Column Refrigerator, Panel Ready, RH	\$ 9,399
F7IRC36O1-L	36"	Panel Ready	Column Refrigerator, Panel Ready, LH	\$ 9,399

Optional Accessories

MODEL	FINISH	DESCRIPTION	UMRP
REFJOINKITWH	Panel Ready	Universal Joining Kit for Column Refrigeration, White	\$ 279
REFSBSINT60	Panel Ready	Joining Strip Only for Panel Ready Columns, White	\$ 269
REFSBSICGR60	Stainless Steel	Joining Kit for Column Refrigeration, Gray	\$ 259
REFHANDPROCOL	Panel Ready	Sofia Column Handle Kit for Panel Ready Units	\$ 309
90STOP		90 Degree Door Stop	\$ 40.50

Inventory levels are subject to change, check stock via Dealer Login on www.pinnaclesalesgroup.com

SOFIA REFRIGERATION - COLUMN FREEZERS

Series 700



F7SFC / F7IFC

Column Freezer
Series: 700

Features

- Lateral Airflow Curtain
- Brilliant White Aluminum and Stainless Steel Interior
- Extra Deep Storage Capacity
- Total No Frost
- Metal Freezer Bins on Stainless Steel Glides
- Filtered Ice Maker with Adjustable Cube Sizes
- Multilevel LED Lighting
- Interior LED Digital Touch Interface
- Super Quiet 41 dB Noise Level
- Available in Stainless Steel and Panel Ready Options
- Joining Kit is Included (White)
- Freezer Available in Widths: 18", 24", 30" and 36"

Product Information

MODEL	WIDTH	FINISH	DESCRIPTION	UMRP
F7SFC18S1-L	18"	Stainless Steel	Column Freezer, LH	\$ 8,599
F7SFC18S1-R	18"	Stainless Steel	Column Freezer, RH	\$ 8,599
F7IFC18O1-L	18"	Panel Ready	Column Freezer, Panel Ready, LH	\$ 8,399
F7IFC18O1-R	18"	Panel Ready	Column Freezer, Panel Ready, RH	\$ 8,399
F7SFC24S1-L	24"	Stainless Steel	Column Freezer, LH	\$ 8,699
F7SFC24S1-R	24"	Stainless Steel	Column Freezer, RH	\$ 8,699
F7IFC24O1-L	24"	Panel Ready	Column Freezer, Panel Ready, LH	\$ 8,499
F7IFC24O1-R	24"	Panel Ready	Column Freezer, Panel Ready, RH	\$ 8,499
F7SFC30S1-L	30"	Stainless Steel	Column Freezer, LH	\$ 9,099
F7SFC30S1-R	30"	Stainless Steel	Column Freezer, RH	\$ 9,099
F7IFC30O1-L	30"	Panel Ready	Column Freezer, Panel Ready, LH	\$ 8,999
F7IFC30O1-R	30"	Panel Ready	Column Freezer, Panel Ready, RH	\$ 8,999
F7SFC36S1-L	36"	Stainless Steel	Column Freezer, LH	\$ 9,699
F7SFC36S1-R	36"	Stainless Steel	Column Freezer, RH	\$ 9,699
F7IFC36O1-L	36"	Panel Ready	Column Freezer, Panel Ready, LH	\$ 9,499
F7IFC36O1-R	36"	Panel Ready	Column Freezer, Panel Ready, RH	\$ 9,499

Optional Accessories

MODEL	FINISH	DESCRIPTION	UMRP
REFSBSINT60	Panel Ready	Joining Strip Only for Panel Ready Columns, White	\$ 269
REFSBSCGR60	Stainless Steel	Joining Kit for Column Refrigeration, Gray	\$ 259
REFHANDPROCOL	Panel Ready	Sofia Column Handle Kit for Panel Ready Units	\$ 309
90STOP		90 Degree Door Stop	\$ 40.50
1R0000843		Refrigerator Filter Replacement (F7SFC + F7IFC)	\$ 180

Inventory levels are subject to change, check stock via Dealer Login on www.pinnaclesalesgroup.com

SOFIA REFRIGERATION - COLUMN WINE RESERVES

REFRIGERATION

Series 700

F7SWC24S1 / F7IWC24O1

Column Wine Reserve
Series: 700

Features

- Lateral Airflow Curtain
- Two Independent Temperature Zones
- Brilliant White Aluminum and Stainless Steel Interior
- Extra Deep Storage Capacity
- 12 Natural Wood Shelves for 80 Bottles Total Storage Capacity
- Multilevel LED lighting
- Interior LED Digital Touch Interface
- Super Quiet 41 dB Noise Level
- Available in Stainless Steel and Panel Ready Options
- Joining Kit is Included (White)
- Wine Reserve Available in 24" Width
- Upper Wine Compartment - 50°F - 64°F
- Lower Wine Compartment - 39°F - 55°F



Product Information

MODEL	WIDTH	FINISH	DESCRIPTION	UMRP
F7SWC24S1-R	24"	Stainless Steel	Column Wine Reserve, Dual Zone, RH	\$ 11,499
F7SWC24S1-L	24"	Stainless Steel	Column Wine Reserve, Dual Zone, LH	\$ 11,499
F7IWC24O1-R	24"	Panel Ready	Column Wine Reserve, Dual Zone, Panel Ready, RH	\$ 10,899
F7IWC24O1-L	24"	Panel Ready	Column Wine Reserve, Dual Zone, Panel Ready, LH	\$ 10,899

Optional Accessories

MODEL	FINISH	DESCRIPTION	UMRP
REFSBSINT60	Panel Ready	Joining Strip Only for Panel Ready Columns, White	\$ 269
REFSBSCLR60	Stainless Steel	Joining Kit for Column Refrigeration, Gray	\$ 259
REFHANDPROCOL	Panel Ready	Sofia Column Handle Kit for Panel Ready Units	\$ 269
90STOP		90 Degree Door Stop	\$ 40.50

Inventory levels are subject to change, check stock via Dealer Login on www.pinnaclesalesgroup.com

SOFIA REFRIGERATION - BUILT-IN REFRIGERATOR

Series 700



Stainless Model

Panel Ready Model

See previous page for interior details

F7PBM36S1 / F7IBM3601

36" Professional Refrigerator
Series: 700

Features

- Flexzone Bottom Drawer that can be converted to refrigerator, freezer or fresco
- Lateral Airflow Curtain
- Brilliant White Aluminum and Stainless Steel Interior
- Extra Deep Storage Capacity
- Automatic Defrost System
- Full Extension Stainless Steel Soft Close Drawers
- Filtered Ice Maker with Adjustable Cube Sizes
- LED Lighting
- Interior LED Digital Touch Interface
- Super Quiet 41 dB Noise Level
- Available in Stainless Steel and Panel Ready Options

REFRIGERATION

Product Information

MODEL	WIDTH	FINISH	DESCRIPTION	UMRP
F7PBM36S2-L	36"	Stainless Steel	Professional Refrigerator, Left Hinge	\$ 11,499
F7PBM36S2-R	36"	Stainless Steel	Professional Refrigerator, Right Hinge	\$ 11,499
F7IBM3602-L	36"	Panel Ready	Refrigerator, Left Hinge	\$ 10,699
F7IBM3602-R	36"	Panel Ready	Refrigerator, Right Hinge	\$ 10,699

Optional Accessories

MODEL	DESCRIPTION	UMRP
FXJTRIMSS	Stainless Steel Frame Kit for Top Compressor Units (X-Pro)	\$ 299
REFSBSPRO60	Sofia 1-Piece Joining Kit (Incl. Joining Strip, 60" 1-Piece Upper Grill, Toe Kick and Insulated Blanket)	\$ 1,439
REFSBSPRO72	Sofia 1-Piece Joining Kit (Incl. Joining Strip, 72" 1-Piece Upper Grill, Toe Kick and Insulated Blanket)	\$ 1,549
REFSBSINT60	Joining Strip Only for Integrated Units	\$ 269
REFHANDPRO36	Sofia 36" Refrigerator PRO Handle for Panel Ready or Stainless Steel Model	\$ 479
1R0000843	Refrigerator Filter Replacement (F7PBM36S1 & F7IBM3601)	\$ 180
90STOP	90 Degree Door Stop	\$ 40.50

Inventory levels are subject to change, check stock via Dealer Login on www.pinnaclesalesgroup.com

SOFIA REFRIGERATION - BUILT-IN WINE RESERVES

REFRIGERATION

Series 700

F7PBW24S1 / F7IBW24O1

24" Wine Reserve

Series: 700

Features

- 3 Independent Temperature Zones
- Flexzone Bottom Drawer that can be converted to refrigerator, freezer or fresco
- Upper Wine Compartment - 50°F - 64°F
- Lower Wine Compartment - 39°F - 55°F
- Cellar Storage Top Compartment with Natural Wood Shelves for 36 Bottles
- Wine Cellar Bottom Compartment with Natural Wood Shelves for 18 Bottles
- Lateral Airflow Curtain
- Automatic Defrost System
- LED Lighting
- Brilliant White Aluminum Interior
- Extra Deep Storage Capacity
- Available in Stainless Steel and Panel Ready Options



Stainless Version

Panel Ready Version

Product Information

MODEL	WIDTH	FINISH	DESCRIPTION	UMRP
F7PBW24S1-L	24"	Stainless Steel	Professional Wine Reserve, Left Hinge	\$ 12,699
F7PBW24S1-R	24"	Stainless Steel	Professional Wine Reserve, Right Hinge	\$ 12,699
F7IBW24O1-L	24"	Panel Ready	Wine Reserve, Left Hinge	\$ 11,799
F7IBW24O1-R	24"	Panel Ready	Wine Reserve, Right Hinge	\$ 11,799

Optional Accessories

MODEL	DESCRIPTION	UMRP
REFHANDPRO24	Sofia 24" Refrigerator PRO Handle Kit for Panel Ready or Stainless Steel Models	\$ 409
90STOP	90 Degree Door Stop	\$ 40.50

Inventory levels are subject to change, check stock via Dealer Login on www.pinnaclesalesgroup.com

STOCK ITEMS ARE LISTED IN RED

REFRIGERATION - BUILT-IN REFRIGERATOR

Series 400 Refrigerator

FM4BM30

30" and 36" Built-In Refrigerator
Series: 400

Features

- Contemporary European Design
- Hettich™ Hinge System
- Digital Display
- Soft Close Crisper
- Soft Close Pantry Drawer
- Temperature Alarm
- Fast Cooling/Freezing Feature
- Glass Shelves
- LED Lighting
- Field Reversible Doors
- Ultra-Quiet Operation - 43 dB
- Height Adjustable Cantilever Shelves
- Optional Interior Filtered Water Dispenser and Automatic Ice Maker IF Built-In
- Sabbath Mode
- 84 1/2" Tall for Built-In Installation



REFRIGERATION

Product Information

	MODEL	WIDTH	FINISH	DESCRIPTION	UMRP
NEW	FM4BM30IFBI	30"	Panel Ready (w/Ice & Water)	Built-In Refrigerator	\$ 4,999
NEW	FM4BM30FBI	30"	Panel Ready	Built-In Refrigerator	\$ 4,199
NEW	FM4BM36IFBI	36"	Panel Ready (w/Ice & Water)	Built-In Refrigerator	\$ 7,199

Optional Accessories

MODEL	DESCRIPTION	UMRP
F4HKPRO30BM	Sofia Pro Handle Kit for 30" Built-In Refrigerators	\$ 369
F4HKPRO36BM	Sofia Pro Handle Kit for 36" Built-In Refrigerators	\$ 399
F4PANEL30BMSS	Stainless Panel for 30" Refrigerator	\$ 1,479
F4PANEL36BMSS	Stainless Panel for 36" Refrigerator	\$ 1,499
FM4JOINKIT	Joining Kit for 400 Series Built-In Refrigerators	\$ 339
90STOP	90 Degree Door Stop	\$ 40.50
FH000740801	Refrigerator Filter Replacement	\$ 86.50

Inventory levels are subject to change, check stock via Dealer Login on www.pinnaclesalesgroup.com

REFRIGERATION - BUILT-IN REFRIGERATOR

REFRIGERATION

Series 400 Refrigerator

FM4FBM36

36" Built-In French Door Refrigerator
Series: 400

Features

- Contemporary European Design
- Hettich™ Hinge System
- Digital Display
- Soft Close Crisper
- Soft Close Pantry Drawer
- Temperature Alarm
- Fast Cooling/Freezing Feature
- Glass Shelves
- LED Lighting
- Field Reversible Doors
- Ultra-Quiet Operation - 43 dB
- Height Adjustable Cantilever Shelves
- Interior Filtered Water Dispenser and Automatic Ice Maker Built-In
- Sabbath Mode
- 84 1/2" Tall for Built-in



FM4FBM36FBI

Product Information

	MODEL	WIDTH	FINISH	DESCRIPTION	UMRP
NEW	FM4FBM36IFBI	36"	Panel Ready (w/Ice & Water)	Built-In French Door Refrigerator	\$ 8,199

Optional Accessories

MODEL	DESCRIPTION	UMRP
F4PANEL36FDSS	Stainless Panel for 36" French Door Refrigerator	\$ 1,999
F4HKPRO36FD	Sofia Pro Handle Kit for 36" Built-In French Door Refrigerator	\$ 449
FH00740801	Refrigerator Filter Replacement	\$ 86.50

Inventory levels are subject to change, check stock via Dealer Login on www.pinnaclesalesgroup.com

REFRIGERATION - FREESTANDING REFRIGERATOR

REFRIGERATION

SOFIA
Professional 400
REFRIGERATION

NEW



FM4FBM36SS

36" Professional Counter Depth Refrigerator
Series:400

Features

- 20.3 cubic feet in size
- Includes a Sofia Professional handle
- Electronic control on top of the cabinet
- Fridge compartment has a stainless-steel back panel
- Three crisper drawers with humidity adjustment on vegetable crispers
- Six-door bins in refrigeration, including two-gallon bins
- LED lighting
- Automatic ice maker (up to five pounds per day)
- Frost free
- One inner drawer inside the freezer drawer
- External water filter recommended
- One-year parts and labor warranty

Product Information

MODEL	WIDTH	FINISH	DESCRIPTION	UMRP
FM4FBM36SS	36"	Stainless Steel	Freestanding Refrigerator	\$ 3,499

Inventory levels are subject to change, check stock via Dealer Login on www.pinnaclesalesgroup.com

FULGOR

MILANO



DISHWASHERS

Series 700 Dishwashers

F7DWT24

24" Dishwashers
Series: 700



F7DWT24SS1
Shown with F7HK24DISHS
Handle Kit

Features

- Ultra Quiet - 42 dB
- Stainless Steel Interior Tub
- 8 Wash Cycles
- Turbo Dry
- Built-In Top Touch Control
- Full-Width 3rd Rack Adjustable
- Interior Light
- Ball Bearing Smooth Glide 2nd Level Basket
- Flow-Through Internal Heater
- 3-Way Filtering System
- Adjustable Hinge System
- Front Adjustable Rear Feet
- Airbreak with Drain Backsiphonage Preventer
- Overflow & Leakage Protection
- Stainless Steel Wash Arms

Product Information

	MODEL	WIDTH	FINISH	DESCRIPTION	UMRP
NEW	F7DWT24SS1	24"	Stainless Steel	700 Series Dishwasher	\$ 1,249
NEW	F7DWT24FI1	24"	Panel Ready	700 Series Dishwasher	\$ 1,149
	F6UHK24DISH	24"	Sofia	Sofia Handle and Badge Kit	\$ 159

Inventory levels are subject to change, check stock via Dealer Login on www.pinnaclesalesgroup.com

ADA DISHWASHERS

DISHWASHERS

Series 700
Dishwashers

F7DWS24FI1

24" ADA Dishwashers
Series: 700



Shown with F6UHK24DISH
Handle Kit



Features

- Ultra Quiet - 42 dB
- Stainless Steel Interior Tub
- 8 Wash Cycles
- Turbo Dry
- Built-In Top Touch Control
- Full-Width 3rd Rack Adjustable
- Interior Light
- Ball Bearing Smooth Glide 2nd Level Basket
- Flow-Through Internal Heater
- 3-Way Filtering System
- Adjustable Hinge System
- Front Adjustable Rear Feet
- Airbreak with Drain Backsiphonage Preventer
- Overflow & Leakage Protection
- Stainless Steel Wash Arms

Product Information

MODEL	WIDTH	FINISH	DESCRIPTION	UMRP
F7DWS24FI1	24"	Panel Ready	700 Series ADA Dishwasher	\$ 1,149
F6UHK24DISH	24"	Sofia	Sofia Handle and Badge Kit	\$ 159

Inventory levels are subject to change, check stock via Dealer Login on www.pinnaclesalesgroup.com

Series 400

Dishwashers

F4DWT

24" Dishwashers
Series: 400



Features

- Quiet Plus - 49 dB
- Stainless Steel Interior Tub
- 6 Wash Cycles
- Flexible Rack Loading
- 14 Place Settings
- Super Active Drying
- Fully Built-In
- Top Control
- Adjustable Feet
- Adjustable Hinge System
- 2 Foldable Racks
- Upper Basket
- Advanced Filtering system

Product Information

MODEL	WIDTH	FINISH	DESCRIPTION	UMRP
F4DWT24SS1	24"	Stainless Steel	400 Series Dishwasher	\$ 929
F4DWT24FI1	24"	Panel Ready	400 Series Dishwasher	\$ 849
F4DWT24DS1	24"	Stainless Steel	400 Series Dishwasher with Distinto Handle Included	\$ 959
F6UHK24DISH	24"	Sofia	Sofia Handle and Badge Kit	\$ 159

Inventory levels are subject to change, check stock via Dealer Login on www.pinnaclesalesgroup.com

ADA DISHWASHERS

DISHWASHERS

Series 400
Dishwashers

F4DWS

18" & 24" ADA Dishwashers

Series: 400



Features

- ADA Compliant
- Quiet Plus - 49 dB
- Stainless Steel Interior Tub
- 6 Wash Cycles
- Flexible Rack Loading
- 14 Place Settings
- Super Active Drying
- Fully Built-In
- Top Control
- Adjustable Feet
- Adjustable Hinge System
- 2 Foldable Racks
- Upper Basket
- Advanced Filtering system

Product Information

MODEL	WIDTH	FINISH	DESCRIPTION	UMRP
F4DWS24FI1	24"	Panel Ready	400 Series ADA Dishwasher	\$ 829
F4DWS18FI1	18"	Panel Ready	400 Series ADA Dishwasher	\$ 849

Inventory levels are subject to change, check stock via Dealer Login on www.pinnaclesalesgroup.com



VENTILATION

LINER INSERTS

VENTILATION

Series ⁴⁰⁰ & ⁶⁰⁰
Inserts

F4BP28S1/ F6BP34DS1 / F6BP46DS1

28", 34", 46" Baffle Filter Professional Insert
Series: 400 & 600



F6BP34S1



F6BP34DS1

Features

- Scotch Bright Stainless Steel
- Heavy Duty Control Panel with Knobs
- LED Lighting
- Slider Control on 28" Model Only
- 600 CFM or 1000 CFM
- Dual Fan Motors on 1,000 CFM Models
- Professional Baffle Filters

Product Information

MODEL	WIDTH	FINISH	CFM	DESCRIPTION	UMRP
F4BP28S1	28"	Stainless Steel	600	Insert Baffle Filter	\$ 899
F6BP34S1	34"	Stainless Steel	600	Insert Baffle Filter	\$ 1,299
F6BP34DS1	34"	Stainless Steel	1000	Sofia Insert Baffle Filter	\$ 1,379
F6BP46DS1	46"	Stainless Steel	1000	Sofia Insert Baffle Filter	\$ 1,549

Optional Accessories

MODEL	DESCRIPTION	UMRP
FMFIL	Round Carbon Recirculating Filter	\$ 69

Inventory levels are subject to change, check stock via Dealer Login on www.pinnaclesalesgroup.com

STOCK ITEMS ARE LISTED IN RED

SOFIA Professional Hoods 600

F6PC36/F6PC48 Hood

36" , 48" Professional Chimney Hood
Series: 600



Features

- Scotch Brite Stainless Steel
- Heavy Duty Control Panel with Knobs
- 3 Speed Settings
- LED Lighting
- Dual Fan Motors
- Professional Baffle Filters
- 1,000 CFM
- Optional Logo Badge
- Adjustable Duct Extension for up to 9' Ceiling

Product Information

MODEL	WIDTH	FINISH	CFM	DESCRIPTION	UMRP
F6PC36DS1	36"	Stainless Steel	1000	Sofia Hood Baffle Filter	\$ 2,179
F6PC48DS1	48"	Stainless Steel	1000	Sofia Hood Baffle Filter	\$ 2,459

Optional Accessories

MODEL	DESCRIPTION	UMRP
FMFIL	Round Carbon Recirculating Filter	\$ 69
KCPHN.00#3	Adjustable Chimney Extension (Max 60" / For 36" and 48" hoods)	\$ 309

Inventory levels are subject to change, check stock via Dealer Login on www.pinnaclesalesgroup.com

SOFIA HOODS

VENTILATION

SOFIA
Professional Hoods 600

F6PH Hood

30", 36", and 48" Professional Hood
Series: 600



F6PH30S1 / F6PH36S1

- Scotch Bright Stainless Steel
- Slider Controls
- 4 Speed Control
- LED Lighting
- Single Fan Motor
- Professional Baffle Filters

F6PH30S2 / F6PH36DS1 / F6PH48DS1

- Scotch Bright Stainless Steel
- Heavy Duty Control Panel with Knobs
- 4 Speed Control
- LED Lighting
- Dual Fan Motors (1000 CFM Models)
- Professional Baffle Filters

Product Information

MODEL	WIDTH	FINISH	CFM	DESCRIPTION	UMRP
F6PH30S1	30"	Stainless Steel	600	Sofia Hood, Slide Controls	\$ 1,299
F6PH30S2	30"	Stainless Steel	600	Sofia Hood, Knob Controls	\$ 1,399
F6PH36S1	36"	Stainless Steel	600	Sofia Hood, Slide Controls	\$ 1,699
F6PH36DS1	36"	Stainless Steel	1000	Sofia Hood, Knob Controls	\$ 2,099
F6PH48DS1	48"	Stainless Steel	1000	Sofia Hood, Knob Controls	\$ 2,349

Optional Accessories

MODEL	DESCRIPTION	UMRP
F6CK30-12	30" Chimney Extension Cover, 12" Tall	\$ 269
F6CK36-12	36" Chimney Extension Cover, 12" Tall	\$ 299
F6CK48-12	48" Chimney Extension Cover, 12" Tall	\$ 319
FMFIL	Round Carbon Recirculating Filter	\$ 69

Inventory levels are subject to change, check stock via Dealer Login on www.pinnaclesalesgroup.com

COLLECTION HOODS - UNDER CABINET HOOD

Series **400**
Hoods

F4UC30S1 & F4UC36S1
30" & 36" Under Cabinet Hood
Series: 400

VENTILATION



F4UC30S1



F4UC36S1

Features

- Scotch Bright Stainless Steel
- 450 CFM
- Electronic Controls
- LED Lighting
- Hybrid Baffle Filters
- PDS (Power Dampening System) can reduce the max speed (permanently) of the hood to 395 and 295 cfm

Product Information

MODEL	WIDTH	FINISH	DESCRIPTION	UMRP
F4UC30S1	30"	Stainless Steel	Under Cabinet Hood	\$ 1,079
F4UC36S1	36"	Stainless Steel	Under Cabinet Hood	\$ 1,179

Optional Accessories

MODEL	DESCRIPTION	UMRP
FMFIL	Round Carbon Recirculating Filter	\$ 69

Inventory levels are subject to change, check stock via Dealer Login on www.pinnaclesalesgroup.com

COLLECTION HOODS - HOOD

VENTILATION

Series **400**
Hoods

F4CW30 & F4CW36

30" & 36" Wall Mount Chimney Hood
Series: 400



Features

- Scotch Brite 304 Stainless Steel
- Electronic Controls
- 4 Speed Settings
- LED Lighting
- Hybrid Baffle Filters
- 600 CFM
- Optional Recirculating Kit
- Adjustable Duct Extension for up to 9' Ceilings
- PDS (Power Dampening System) can reduce the max speed (permanently) of the hood to 395 and 295 cfm

Product Information

MODEL	WIDTH	FINISH	CFM	DESCRIPTION	UMRP
F4CW30S1	30"	Stainless Steel	600	Baffle Filter Hood	\$ 1,279
F4CW36S1	36"	Stainless Steel	600	Baffle Filter Hood	\$ 1,349

Optional Accessories

MODEL	DESCRIPTION	UMRP
FMFILCW	Square Charcoal Filter	\$ 39
KACL.512#I	Duct Extension - 38" (for 12' Ceiling)	\$ 219
KACL.510#I	Duct Extension - 27" (for 11' Ceiling)	\$ 209

Inventory levels are subject to change, check stock via Dealer Login on www.pinnaclesalesgroup.com

LINE DRAWING MAP FOR PROFESSIONAL BUILT-IN OVENS
SINGLE AND DOUBLE

A.

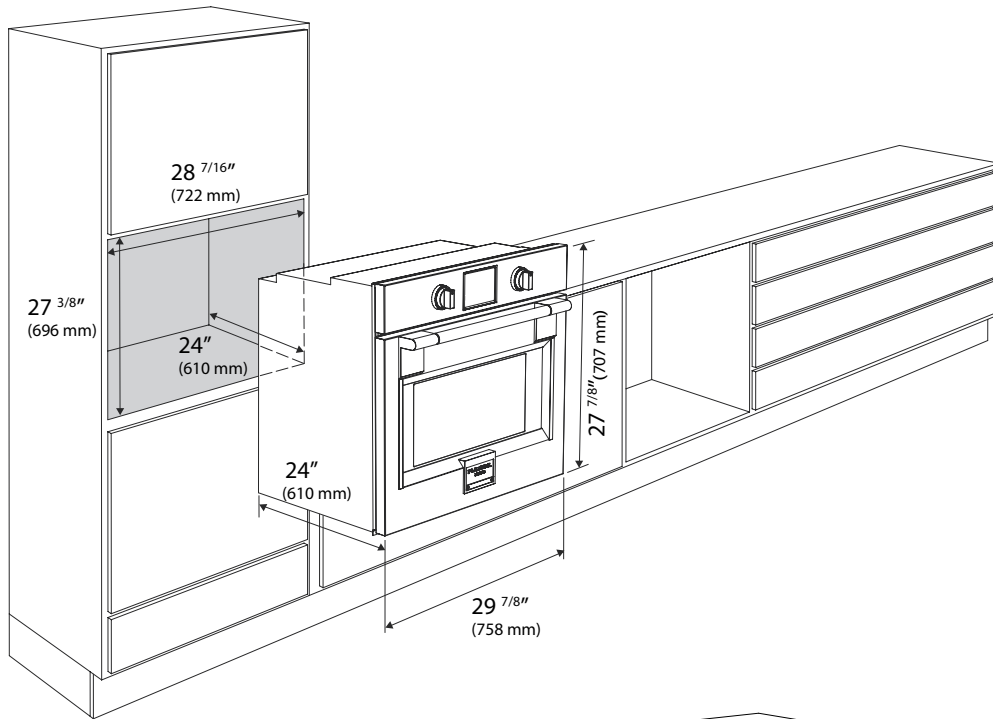

B.

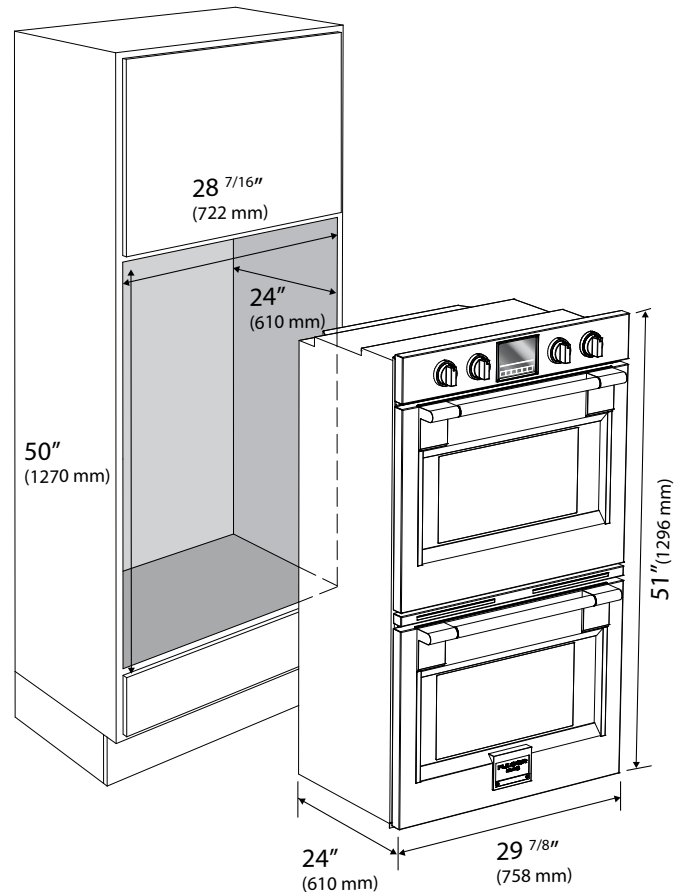

A. F6PSP30S1 (p.17)
30" Professional Single Oven
Series: 600

B. F6PDP30S1 (p.18)
30" Professional Double Oven
Series: 600

Warranty Class	Description of Warranty Coverage
0	Doors, handles, glass, product frames, racking, interior and exterior surfaces are covered by a limited 30-day parts-only warranty for cosmetic defects proven to have originated from the factory. It is the responsibility of the owner to inspect the product and report any such claims within this 30 day period.
1	1 year parts and labor
2	2 years parts and labor
5	5 years parts and labor on the following sealed system components only: compressor, condenser, evaporator, dryer and connective tubing
5p	5 years parts only on the following sealed system components only: compressor, condenser, evaporator, dryer and connective tubing
12p	12 years parts only on the following sealed system components only: compressor, condenser, evaporator, dryer and connective tubing

Product Class	Applicable Warranties	
Cooking		
Drop-in Cooktops	0,2	
Built-in Ovens	0,2	
Rangetops	0,2	
Microwaves	0,1	
Freestanding Ranges	0,2	
Cleaning (Dishwashers)		
600 Series	400 Series	
0,2	0,1	
Refrigeration		
700 Series	600 Series	400 Series
0,2,5,12p	0,2,5p	0,1
Ventilation		
Ventilation Hoods	0,2	

For proof of warranty, please retain the original purchase invoice and the delivery slip.

To obtain service under these warranties you must:

- Contact Pinnacle Sales Group Authorized Service
 - By email at service@pinnaclesalesgroup.com
 - Log all your information on www.pinnaclesalesgroup.com under **Service Request** for immediate assistance.
 - Toll free at 800-292-8374.
- Provide a copy of your original sales receipt along with model number and serial number information for the product.
- Provide Fulgor Milano reasonable opportunity to investigate the claim before the product or any component of the product has been modified or removed.

TERMS APPLICABLE TO THESE WARRANTIES

All applicable warranties for each class run concurrently. In accordance to the applicable warranty class, Fulgor Milano warranty covers all parts and / or labor to repair or replace, under normal residential use, any part of the product proving to be defective in material or workmanship as a result of the original manufacturing process.

These warranties is valid only in the contiguous states of the U.S.A. including the District of Columbia and Alaska and the country of Canada. These warranties apply to the original purchaser only and are non-transferable. All service provided by Fulgor Milano under the applicable warranty must be performed by a Fulgor Milano authorized servicer unless otherwise specified in writing by Fulgor Milano. Service will be provided during the regular business hours of each specific region. These warranties apply only to products purchased from an authorized dealer through an approved distribution chain and which are installed for normal residential use and do not apply to commercial use or use on yachts. These warranties only cover service performed at the location of product installation and will not cover costs associated with repairing off-site unless expressly authorized by Fulgor Milano nor does it cover the travel costs associated with providing service to remote locations. Remote locations are defined as being outside of a 50 mile (80 kilometre) radius from any authorized 'brick and mortar' dealer. These warranties do not cover any parts or labor needed to correct any defect caused by negligence, transport, delivery, improper voltage or accident or improper use, maintenance, installation, service or repair, including but not limited to improper removal and reinstallation of any component of the product (ie. removing handles to fit through doors) prior to or during product delivery / installation. The remedies described herein are the only ones which Fulgor Milano will provide, either under these warranties or under any warranty arising by operation of law. Fulgor Milano will not be responsible for content loss due to spoilage, freezing or burning nor for consequential damages to surrounding cabinetry, construction materials or

finishing materials such as but not limited to flooring. Fulgor Milano will not be responsible for any consequential or incidental damages arising from the breach of these warranties or any other warranties, whether express, implied or statutory. The warranty will be valid and effective only upon presentation of the document stating the purchase date of the appliance, and more specifically of the relevant invoice, proof of purchase or equivalent document showing the name of the seller, the delivery date and the identification data of the appliance (such as; model number and serial number). In the case of new product being included in the purchase of new residential construction; these warranties apply to the original resident of the location containing the Fulgor Milano product and warranty coverage will begin on the date of occupancy of the residence (proof of occupancy required) to a maximum additional six months from the date of delivery of the product by the development company from the distributor or dealer. This extension does not apply to the Class 0 cosmetic warranty. These warranties are only valid where the difference between the purchase date and the production date of the product is less than eighteen months. Any product which has been warehoused for more than this period will only be covered by Fulgor Milano's B-Stock warranty. During the warranty period Fulgor Milano reserves the right to evaluate the opportunity to repair the appliance or, at their discretion, offer to replace it with a Fulgor Milano product of equivalent features and functionality but cannot guarantee that the exact model will still be available. Fulgor Milano reserves the right to revise these warranties at any time. Some states do not allow the exclusion or limitation of incidental or consequential damages so the above limitation or exclusion may not apply to you. These warranties give you specific legal rights and you may also have other rights which vary from state to state.

*Replacement light bulbs / LEDs are only covered under the terms of the Class 0, 30 day cosmetic warranty.

Orders: All orders and any subsequent change orders must be submitted in writing and delivered to Pinnacle Express, Inc. dba Pinnacle Sales Group by mail, fax, website, EDI or email. No telephone orders will be accepted. Special Order items are Non-Cancellable.

Prices: All prices are subject to change without notice and are exclusive of any sales or use taxes, shipping, delivery, special packaging, or handling charges that may apply to each customer or to each order.

Minimum Advertised Pricing: All sales are subject to Pinnacle Express, Inc. dba Pinnacle Sales Group or Manufacturer minimum advertised prices. Failure to comply with minimum advertised prices will result in cancellation of any agreement and violators will not be entitled to purchase further products.

Minimum Sale Price: All sales are subject to Pinnacle Express, Inc. dba Pinnacle Sales Group or Manufacturer minimum sale prices. Failure to comply with minimum sale prices will result in cancellation of any agreement and violators will not be entitled to purchase further products.

Freight and Handling: Pinnacle Express, Inc. dba Pinnacle Sales Group reserves the right to ship products by its choice of carrier. All shipments are F.O.B. from place of shipment, and risk of loss shall pass to the Buyer upon delivery to the carrier at the point of shipment. Additional charges may apply for special handling and packaging.

Deliveries: Pinnacle Express, Inc. dba Pinnacle Sales Group shall not be liable for failure to deliver or for delays in delivery or performance due to: (1) causes beyond its reasonable control; (2) acts of God, acts of Buyer, acts of civil or military authority, governmental allocations or controls, fires, strikes or other labor difficulties, riots or other civil disturbances, delays in its usual source of supply, delays in transportation; (3) any other commercial impracticability. In the event of such delay, the date of delivery or performance shall be extended for a period equal to the time lost by reason of the delay.

Claims: All claims for non-conforming delivery of Products must be made within thirty (30) days of receipt of shipment.

Damage or Loss: Any claim for damage or loss in shipment should be made to the carrier immediately by the customer. Products become the responsibility of the Buyer when accepted by the carrier in good condition from Pinnacle Express, Inc. dba Pinnacle Sales Group and we are not able to process shipping damage claims.

Returns: Only Items marked in this Price List as "Stock Item" are subject to return. All other items are considered Special Order Items and are NOT RETURNABLE. No Products may be returned without a Pinnacle Express, Inc. dba Pinnacle Sales Group Return Goods Authorization (RGA) Number issued prior to the return of Product. Any product returned without an RGA will be refused and returned to the sender. RGA's are valid for thirty (30) days only. All returns are subject to inspection before being approved for credit - products must be in salable condition to be considered for return or replacement. A 20% restocking charge will apply to all returns.

Payment: Unless otherwise noted, payment terms are Net Due on Receipt. Balances owed on invoices over 30 days old are subject to a 1.5% per month charge. Payments made by credit card are subject to a 2% processing fee. Each shipment or delivery shall be deemed to have been sold under a separate and or independent contract and payment thereof shall be made in accordance with the terms of this agreement and of the invoice rendered by Pinnacle Express, Inc. dba Pinnacle Sales Group Buyer agrees that title to the personal property described herein shall not vest in Buyer until paid in full. In the event of insolvency or the filing of bankruptcy by the Buyer, Buyer agrees to return all merchandise to Pinnacle Express, Inc. dba Pinnacle Sales Group

Warranties: Products distributed by Pinnacle Express, Inc. dba Pinnacle Sales Group are the products of reputable manufacturers sold under their respective brand or trade names. Pinnacle Express, Inc. dba Pinnacle Sales Group shall use its best efforts to obtain from each manufacturer, in accordance with the manufacturer's warranty or customary practice, the repair or replacement of products that may prove defective in material or workmanship. The foregoing shall constitute the exclusive remedy of the Buyer and the sole obligation of Pinnacle Express, Inc. dba Pinnacle Sales Group Except as to Title, THERE ARE NO WARRANTIES, EITHER WRITTEN, ORAL, IMPLIED, OR STATUTORY relating to the described products which shall extend beyond that described in this paragraph. NO WARRANTY OF MERCHANTABILITY OR OF FITNESS FOR PURPOSE SHALL APPLY.

Limitation of Liability: Pinnacle Express, Inc. dba Pinnacle Sales Group's liability on any claims for loss or damage arising out of this contract or from the performance or breach thereof or connected with the supplying of products hereunder, or its sale, resale, operation or use, whether based on warranty, contract, negligence or other grounds shall not exceed the price allowable for such products or parts thereof involved in the claim. Pinnacle Express, Inc. dba Pinnacle Sales Group shall not, under any circumstances, be liable for any labor charges unless agreed upon in advance and in writing by Pinnacle Express, Inc. dba Pinnacle Sales Group and the manufacturer of the products involved. Pinnacle Express, Inc. dba Pinnacle Sales Group shall not in any event be liable for special or consequential damages, including, but not limited to, loss of profits or revenue, loss of use of the product or any associated product, cost of capital, cost of substitute products, facilities or services, downtime costs, or claims of customers of the Buyer for such damages.

General: The possession of this Price List by anyone is not to be considered as an offer to sell any of the Products contained herein. This Price List supercedes all previous price lists or memorandums. Pinnacle Express, Inc. dba Pinnacle Sales Group's existing Trade Terms and Conditions remain in effect. The above Terms and Conditions shall be a part of all Orders accepted by Pinnacle Express, Inc. dba Pinnacle Sales Group and shall supercede any conflicting provisions of our customer's purchase orders. These terms and conditions are subject to change without notice.



PINNACLE
SALES GROUP



Pinnacle Sales Group

P.O. Box 1836 • Dundee, FL 33838

Phone: 800-292-8374

www.pinnaclesalesgroup.com

FM-PB-202501