



U-LINE AND MARVEL PRICE BOOK



See Our Current
Price Book



U-LINE AND MARVEL PRICE BOOK

Effective January 1, 2025

800-292-8374

www.pinnaclesalesgroup.com



U-LINE

U-Line creates products designed for a modern lifestyle - beautiful and functional refrigeration that properly preserves food, beverages, and wine. With a focus on seamless integration and designer preferred features, U-Line speaks to those seeking a refined aesthetic. Featuring the simplest panel installation in the industry with fully integrated adjustable grilles, U-Line is redefining the industry standard on integration. Refrigeration driven by design since 1962.



With roots in American manufacturing that began in 1892, Marvel is the longest standing refrigeration company in North America. Today, Marvel continues to lead the industry with an extensive line of premium undercounter products known for unrivaled craftsmanship, precise performance, and smart design. When you choose Marvel, you're choosing more than a century of handcrafted American-made quality and intelligent engineering.



TABLE OF CONTENTS

	PAGE
Brightshield	4
U-LINE	6
Built In to Stand Out	6
Why U-Line?	8
Explore the Undercounter Refrigeration Lineup	10
5 CLASS COLLECTION	12
Products (Beverage Centers, Refrigerators, Wine Refrigerators)	13
ICE MAKERS	20
Know Your Ice	20
Finding Your Ideal Ice	22
Ice Makers	23
U-CHILL	26
Cool to the Last Drop	26
U-Chill / U-Chill Plus	27
3000 SERIES	28
Products (Beverage Centers, Refrigerators, Wine Refrigerators)	29
2000 SERIES	33
Products (Beverage Centers, Refrigerators, Wine Refrigerators)	34
1 CLASS	39
Products (Beverage Centers, Refrigerators, Freezers, Wine Refrigerators)	40
OUTDOOR COLLECTION	49
Products (Refrigerators, Freezers, Beverage Dispensers)	50
ADA COLLECTION	53
Products (Refrigerators, Ice Makers)	54
MARINE COLLECTION	58
Products (Refrigerators, Ice Makers)	59
U-LINE ACCESSORIES	61
Marvel	62
130 Years of Crafted Excellence	62
Why Marvel?	64
Collection Comparison	66
PROFESSIONAL COLLECTION	68
Products (Beverage Centers, Refrigerators, Wine Refrigerators, Freezers)	69
ICE MAKERS	77
Ice Makers	78
CLASSIC COLLECTION	84
Products (Beverage Centers, Refrigerators, Wine Refrigerators, Freezers, Beverage Dispensers)	85
OUTDOOR COLLECTION	101
Products (Refrigerators, Freezers, Beverage Dispensers)	102
LOW PROFILE (ADA) COLLECTION	105
Products (Refrigerators, Beverage Center)	106
SCIENTIFIC COMMERCIAL	108
Products (Refrigerators, Freezers)	109
MARVEL ACCESSORIES	110
U-Line and Marvel Corporation Limited Warranty	111
Pinnacle Sales Group Terms and Conditions of Sale	112

U-LINE



BrightShield[®]

Antimicrobial
Protection

WHAT IS BRIGHTSHIELD?

This EPA registered patented LED light protects any surfaces the light touches against viruses, bacteria, mold, and mildew.

- Non-UV continuous antimicrobial light technology.
- 90%-99.99%* reduction in surface contamination.
- Approved for continuous use around people, pets, and plants.
- Proprietary technology with: 22 granted patents
35 pending patents



*Testing on a non-enveloped virus (MS2 bacteriophage showed a 97.12% reduction in controlled laboratory testing in 8 hours on hard surfaces. Testing on SARS-CoV-2 (enveloped virus) showed a 98.45% reduction in controlled laboratory testing in 4 hours on hard surfaces). Testing on MRSA and E. coli showed 90%+ reduction in controlled laboratory testing in 24 hours on hard surfaces. Results may vary depending on the amount of light that is reaching the surfaces in the space where the product is installed and the length of time of exposure. Use of Vyv antimicrobial light is not intended to replace manual cleaning and disinfection practices.



Reference this icon throughout the pricebook for available models featuring BrightShield™

HOW IT WORKS



CASTS A SOFT VIOLET GLOW AROUND THE CLOCK



DESTROYS MICROBIAL CELLS FROM THE INSIDE OUT, OVEROXYGENATING THE CELL



KEEPING THE SURFACES IT TOUCHES FREE FROM CONTAMINATION

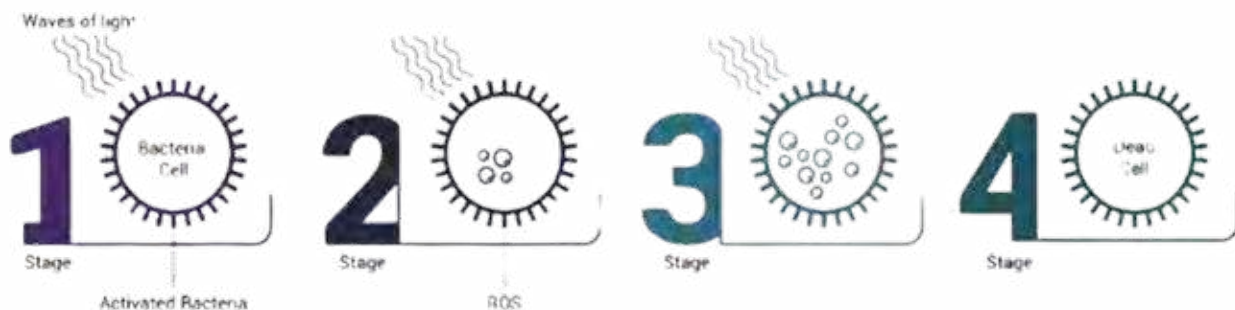

BUILT IN TO STAND OUT

The New Design Standard

With the simplest panel installation on the market and panel panel-ready adjustable grilles, U-Line is redefining the industry standard on integration.

Designer curated features like the capability to install a seamless toe-kick panel shared with surrounding cabinetry to completely blend your appliance in while allowing space for ventilation, and customizable interiors with slide slide-out bins, wine racks, and shelves allow for the best in functionality and beauty.

U-LINE







Why U-Line?

Made in the USA

Rooted in Milwaukee, Wisconsin, U-Line proudly designs, engineers, and assembles all products in the USA. This commitment ensures superior quality control and supports American craftsmanship.

Innovative Design and Seamless Integration

U-Line offers the best integration package in the industry, featuring appliance options like concealed hinges, solid door and glass door panel-ready designs, and adjustable panel-ready toe-kick accessories. These features allow our appliances to blend seamlessly into your cabinetry, letting your design be the focus of the space.

Advanced Cooling Technology

Our products utilize convection cooling systems that provide quick cool down and consistent temperatures, ensuring your food and beverages are preserved at their optimal conditions. This technology is available across a variety of sizes and finishes, offering high-capacity interiors with solid and glass door options.

Energy Efficiency and Sustainability

U-Line is dedicated to leading the industry in energy efficiency, often years ahead of governmental agency and energy requirement mandates. We work closely with various domestic and global agencies such as DOE and AHAM to establish energy standards, ensuring our products are both environmentally friendly and cost-effective to operate.

Versatility and Customization

Our modular refrigeration products allow you to design your kitchen around your needs, not your refrigerator. With advanced refrigeration systems, large and flexible capacities, and seamless integration capabilities, you can preserve the right product, in the right place, at the right temperature.

U-LINE

U-LINE - EXPLORE THE UNDERCOOL

designer pick!

5 Class



- Ultra-Premium Product Line with Industry-Leading Design Features
- Robust Stainless Steel Interior and Exterior
- Zero-Clearance Soft Close Hettich Articulating Hinge for Installations with Minimum Reveals
- Seamless Integration Toe Kick Option
- Variable Speed, High-Output (1574 BTU) Compressor for Quiet, Efficient Operation
- Full-Extension Wine Racks & Bins for Easy Loading and Unloading
- Dual-Pane Argon Gas Filled Glass Doors Reduce Harmful UV's and Increase Efficiency

3000 Series



- Ultra-Premium Product Line with Industry-Leading Design Features
- Soft Close Hettich Articulating Hinge for Installations with Minimum Reveals
- Seamless Integration Toe Kick
- OLED Control Panel with Preset Temperature Modes
- Full-Extension Wine Racks for Easy Loading and Unloading
- Dual-Pane Argon Gas Filled Glass Doors Reduce Harmful UV's and Increase Efficiency
- Built-In Only (Galvanized Cabinet)

2000 Series



- Premium Product Line with Industry-Leading Design Features
- Zero-Clearance Hettich Articulating Hinge for Installations with Tight Reveals
- Full Integration Toe Kick Option
- Field Reversible Doors (Excluding Lock Models)
- Wine Units Offer Full-Extension Coated Racks for Easy Loading and Unloading
- Dual-Pane Argon Gas Filled Glass Doors Reduce Harmful UV's and Increase Efficiency

1 Class



- Mass-Premium with Competitive Price Points, Features & Design, and Offering the Broadest Range of Product Options
- Field Reversible Doors (Including Lock Models)
- Bright White LED Lighting on All Models
- Dual-Pane Argon Gas Filled Glass Doors Reduce Harmful UV's and Increase Efficiency
- Four Types of Ice-Making Products – Crescent, Clear, Craft, and Nugget

UNTER REFRIGERATION LINEUP

COLLECTION COMPARISON CHART

Features	5 Class	3000 Series	2000 Series	1 Class
Interior Color	Stainless Steel Interior and Exterior	Black	Black	Black Select Few are White
Field Reversible Hinge	Yes Except w/ Door Lock	Yes Except w/ Door Lock	Yes Except w/ Door Lock	Yes
Hinge Style	Concealed Articulating Soft Close	Concealed Articulating	Concealed Articulating	Pivot
Cooling System	Variable Speed Convection	Convection	Convection	Convection
Integrated Panel Ready Options	Yes w/ Optional Adjustable Toe Kick	Yes w/ Adjustable Toe Kick	Yes w/ Toe Kick	Yes 024 Models Excluded
Integration Style	Seamless	Seamless	Full	Simple
Application Type	Built-In or Freestanding	Built-In	Built-In	Built-In or Freestanding
Lighting	Blue/White LED Theater	LED Theater	LED	LED
Full-Depth Lower Interior	Yes	No	No	No
Full Extension Removable Bins	Yes	Yes On Select Models	Yes On Select Models	No
U-Adjust Interior	Yes (19 Shelf Adjustments)	No	No	No
Available Sizes	15", 18" & 24"	36"	18" & 24"	15" & 24"
2 Year Warranty Available	Yes Free 3rd Year Available	Yes	Yes	Yes



*designer
pick!*

5 Class Collection

- Ultra-Premium Product Line with Industry-Leading Design Features
- 15", 18", & 24" Sizes
- Robust Stainless Interiors and Exteriors
- Zero-Clearance Soft Close Hettich Articulating Hinge for Installations with Minimum Reveals
- Seamless Integration Toe Kick Option
- Variable Speed, High-Output (1574 BTU) Compressor for Quiet, Efficient Operation
- Field Reversible Doors (Excluding Lock Models)
- Bright White/Blue Programmable LED Lighting
- Full-Extension Wine Racks & Bins for Easy Loading and Unloading
- 19-Point Rack & Bin Adjustments (17 for Dual-Zone Models) for Maximizing Space
- Full-Depth Lower Interiors for Maximum Usability (No Compressor Step)
- Dual-Pane Argon Gas-Filled Glass Doors Reduce Harmful UV Rays and Increase Efficiency
- All Compressors Mounted with Rubber Grommets to Reduce Vibration, Extending Wine Storage Life and Quieter Operation

Available Door Styles



Panel Ready
Glass



Panel Ready
Solid



Stainless Steel
Glass



Stainless Steel
Solid

5 CLASS SINGLE ZONE BEVERAGE CENTERS



Features

- Industry Exclusive: Full-Depth Lower Interior Maximizes Storage Options
- Industry Leading: Variable Speed Compressor for Maximum Energy Efficiency, Faster Temperature Response, and Quieter Operation
- Convection Cooling System Provides Quick Cool Down and Consistent Temperature
- Stainless Steel Interior
- Stainless Steel Cabinet, Grille, and Accents
- U-Adjust™ Interior: 19 Adjustable Positions
- Two Removable Full-Extension Slide & Secure™ Bins
- Two Removable Full-Extension Wine Racks
- Digital Touch Pad Control
- Temperature Range: 33°F to 70°F
- Adjustable Bright White or Blue LED Lighting
- Soft Close Door with Articulating Hinges
- Volume of 5.2 Cu Ft Holds Up to 14 Wine Bottles (750 ml) and 68 Bottles (12 oz) or 111 Cans (12 oz)
- Stainless Steel Handle (7/8" Diameter)
- Integrated Model Requires 3/4" Custom Door Panel and Handle (Not Supplied by U-Line)
- Field Reversible Door Shipped Right-Hand Hinged
- Built-In or Freestanding
- Four Adjustable Leveling Legs
- Floating Toe Kick Accessory Available for Seamless Integration

Single Zone Beverage Centers

MODEL	DESCRIPTION	UMRP	MSRP
UHBV515-IG01A	15" 5 Class Beverage Center, Panel Ready Glass Door	\$ 4,029	\$ 4,439
UHBV515-IS01A	15" 5 Class Beverage Center, Panel Ready Solid Door	\$ 3,899	\$ 4,289
UHBV515-SG01A	15" 5 Class Beverage Center, Stainless Glass Door	\$ 4,099	\$ 4,519
UHBV515-SG41A	15" 5 Class Beverage Center, Stainless Glass Door, RH, Locking	\$ 4,169	\$ 4,589
UHBV515-SG51A	15" 5 Class Beverage Center, Stainless Glass Door, LH, Locking	\$ 4,169	\$ 4,589
UHBV518-IG01A	18" 5 Class Beverage Center, Panel Ready Glass Door	\$ 4,169	\$ 4,589
UHBV518-IS01A	18" 5 Class Beverage Center, Panel Ready Solid Door	\$ 4,029	\$ 4,439
UHBV518-SG01A	18" 5 Class Beverage Center, Stainless Glass Door	\$ 4,229	\$ 4,659
UHBV518-SG41A	18" 5 Class Beverage Center, Stainless Glass Door, RH, Locking	\$ 4,289	\$ 4,719
UHBV518-SG51A	18" 5 Class Beverage Center, Stainless Glass Door, LH, Locking	\$ 4,289	\$ 4,719
UHBV524-IG01A	24" 5 Class Beverage Center, Panel Ready Glass Door	\$ 4,299	\$ 4,739
UHBV524-IS01A	24" 5 Class Beverage Center, Panel Ready Solid Door	\$ 4,179	\$ 4,599
UHBV524-SG01A	24" 5 Class Beverage Center, Stainless Glass Door	\$ 4,369	\$ 4,809
UHBV524-SG41A	24" 5 Class Beverage Center, Stainless Glass Door, RH, Locking	\$ 4,449	\$ 4,889
UHBV524-SG51A	24" 5 Class Beverage Center, Stainless Glass Door, LH, Locking	\$ 4,449	\$ 4,889

See Available Door Styles on Page 12. See Available Accessories on Page 18.

5 CLASS DUAL ZONE BEVERAGE CENTERS



Features

- Independently Controlled Dual-Zones
- Industry Exclusive: Full-Depth Lower Interior Maximizes Storage Options
- Industry Leading: Variable Speed Compressor Delivers Maximum Energy Efficiency, Faster Temperature Response, and Quieter Operation
- Convection Cooling System Provides a Quick Cool Down and Consistent Temperature
- Stainless Steel Interior
- Stainless Steel Cabinet, Grille, and Accents
- U-Adjust™ Interior: 17 Adjustable Positions
- One Removable Full-Extension Slide & Secure™ Bin
- One Removable Full-Extension Stainless Steel Shelf
- Two Removable Full-Extension Wine Racks
- Digital Touch Pad Control
- Temperature Range: (Upper Compartment) 38°F - 65°F; (Lower Compartment) 33°F - 45°F (The Upper Temperature Must Be ≥ the Lower Temperature, Maximum 20° Higher)
- Adjustable Bright White or Blue LED Lighting
- Soft Close Door With Articulating Hinges
- Volume of 5.1 Cu Ft Holds Up to 14 Wine Bottles (750 ml) and 68 Bottles (12 oz) or 72 Cans (12 oz)
- Stainless Steel Handle (7/8" Diameter)
- Integrated Model Requires 3/4" Custom Door Panel and Handle (Not Supplied by U-Line)
- Field Reversible Door Is Shipped Right-Hand Hinged
- Floating Toe Kick Accessory Available for Seamless Integration

Dual Zone Beverage Centers

MODEL	DESCRIPTION	UMRP	MSRP
UHBD524-IG01A	24" 5 Class Dual Zone Beverage Center, Panel Ready Glass Door	\$ 4,999	\$ 5,509
UHBD524-IS01A	24" 5 Class Dual Zone Beverage Center, Panel Ready Solid Door	\$ 4,869	\$ 5,359
UHBD524-SG01A	24" 5 Class Dual Zone Beverage Center, Stainless Glass Door	\$ 5,089	\$ 5,599
UHBD524-SG41A	24" 5 Class Dual Zone Beverage Center, Stainless Glass Door, RH, Locking	\$ 5,149	\$ 5,659
UHBD524-SG51A	24" 5 Class Dual Zone Beverage Center, Stainless Glass Door, LH, Locking	\$ 5,149	\$ 5,659

See Available Door Styles on Page 12. See Available Accessories on Page 18.

5 CLASS REFRIGERATORS



Features

- Industry Exclusive: Full-Depth Lower Interior Maximizes Storage Options
- Industry Leading: Variable Speed Compressor for Maximum Energy Efficiency, Faster Temperature Response, and Quieter Operation
- Convection Cooling System Provides Quick Cool Down and Consistent Temperature
- Stainless Steel Interior
- Stainless Steel Cabinet, Grille, and Accents
- U-Adjust™ Interior: 19 Adjustable Positions
- Three Removable, Full-Extension Slide & Secure™ Bins
- BrightShield™ Available on Select Models 
- Digital Touch Pad Control
- Temperature Range: 33°F to 70°F
- Adjustable Bright White or Blue LED Lighting
- Soft Close Door with Articulating Hinges
- Volume of 5.2 Cu Ft Holds up to 94 Bottles (12 oz) or 148 Cans (12 oz)
- Stainless Steel Handle (7/8" Diameter)
- Integrated Model Requires 3/4" Custom Door Panel and Handle (Not Supplied by U-Line)
- Field Reversible Door Shipped Right-Hand Hinged
- Built-In or Freestanding
- Four Adjustable Leveling Legs
- Floating Toe Kick Accessory Available for Seamless Integration

Refrigerators

MODEL	DESCRIPTION	UMRP	MSRP
UHRE515-IG01A	15" 5 Class Refrigerator, Panel Ready Glass Door	\$ 4,029	\$ 4,439
UHRE515-IS01A	15" 5 Class Refrigerator, Panel Ready Solid Door	\$ 3,899	\$ 4,289
UHRE515-SG01A	15" 5 Class Refrigerator, Stainless Glass Door	\$ 4,099	\$ 4,519
UHRE515-SS01A	15" 5 Class Refrigerator, Stainless Solid Door	\$ 3,959	\$ 4,349
UHRE518-IG01A	18" 5 Class Refrigerator, Panel Ready Glass Door	\$ 4,169	\$ 4,589
UHRE518-IS01A	18" 5 Class Refrigerator, Panel Ready Solid Door	\$ 4,029	\$ 4,439
UHRE518-SG01A	18" 5 Class Refrigerator, Stainless Glass Door	\$ 4,229	\$ 4,659
UHRE518-SS01A	18" 5 Class Refrigerator, Stainless Solid Door	\$ 4,169	\$ 4,589
 UHRE524-IG81A	24" 5 Class Refrigerator, Panel Ready Glass Door, BrightShield	\$ 4,519	\$ 4,979
 UHRE524-IS81A	24" 5 Class Refrigerator, Panel Ready Solid Door, BrightShield	\$ 4,399	\$ 4,829
 UHRE524-SG81A	24" 5 Class Refrigerator, Stainless Glass Door, BrightShield	\$ 4,589	\$ 5,049
 UHRE524-SS81A	24" 5 Class Refrigerator, Stainless Solid Door, BrightShield	\$ 4,349	\$ 4,789
UHRE524-IG01A	24" 5 Class Refrigerator, Panel Ready Glass Door	\$ 4,299	\$ 4,739
UHRE524-IS01A	24" 5 Class Refrigerator, Panel Ready Solid Door	\$ 4,179	\$ 4,599
UHRE524-SG01A	24" 5 Class Refrigerator, Stainless Glass Door	\$ 4,369	\$ 4,809
UHRE524-SS01A	24" 5 Class Refrigerator, Stainless Solid Door	\$ 4,249	\$ 4,679

See Available Door Styles on Page 12. See Available Accessories on Page 18.

5 CLASS SINGLE ZONE WINE REFRIGERATORS



Features

- Industry Exclusive: Full-Depth Lower Interior Maximizes Storage Options
- Industry Leading: Variable Speed Compressor Delivers Maximum Energy Efficiency, Faster Temperature Response, and Quieter Operation
- Convection Cooling System Provides a Quick Cool Down and Consistent Temperature
- Stainless Steel Interior
- Stainless Steel Cabinet, Grille, and Accents
- U-Adjust™ Interior: 19 Adjustable Positions
- Seven Removable, Full-Extension Wine Racks
- Wine Racks Accommodate a Variety of Bottle Shapes and Sizes and Can Be Configured to Store Champagne and Magnum Bottles
- Digital Touch Pad Control
- Temperature Range: 33°F to 70°F
- Adjustable Bright White or Blue LED Lighting
- Soft Close Door With Articulating Hinges
- Volume of 5.2 Cu Ft Holds Up to 49 Wine Bottles (750 ml)
- Stainless Steel Handle (7/8" Diameter)
- Integrated Model Requires 3/4" Custom Door Panel and Handle (Not Supplied by U-Line)
- Field Reversible Door Is Shipped Right-Hand Hinged
- Built-In or Freestanding
- Four Adjustable Leveling Legs
- Floating Toe Kick Accessory Available for Seamless Integration

Single Zone Wine Refrigerators

MODEL	DESCRIPTION	UMRP	MSRP
UHWC515-IG01A	15" 5 Class Wine Refrigerator, Panel Ready Glass Door	\$ 4,299	\$ 4,739
UHWC515-IS01A	15" 5 Class Wine Refrigerator, Panel Ready Solid Door	\$ 4,179	\$ 4,599
UHWC515-SG01A	15" 5 Class Wine Refrigerator, Stainless Glass Door	\$ 4,369	\$ 4,809
UHWC515-SG41A	15" 5 Class Wine Refrigerator, Stainless Glass Door, RH, Locking	\$ 4,449	\$ 4,889
UHWC515-SG51A	15" 5 Class Wine Refrigerator, Stainless Glass Door, LH, Locking	\$ 4,449	\$ 4,889
UHWC518-IG01A	18" 5 Class Wine Refrigerator, Panel Ready Glass Door	\$ 4,449	\$ 4,889
UHWC518-IS01A	18" 5 Class Wine Refrigerator, Panel Ready Solid Door	\$ 4,299	\$ 4,739
UHWC518-SG01A	18" 5 Class Wine Refrigerator, Stainless Glass Door	\$ 4,509	\$ 4,959
UHWC518-SG41A	18" 5 Class Wine Refrigerator, Stainless Glass Door, LH, Locking	\$ 4,589	\$ 5,049
UHWC518-SG51A	18" 5 Class Wine Refrigerator, Stainless Glass Door, RH, Locking	\$ 4,589	\$ 5,049
UHWC524-IG01A	24" 5 Class Wine Refrigerator, Panel Ready Glass Door	\$ 4,859	\$ 5,349
UHWC524-IS01A	24" 5 Class Wine Refrigerator, Panel Ready Solid Door	\$ 4,719	\$ 5,189
UHWC524-SG01A	24" 5 Class Wine Refrigerator, Stainless Glass Door	\$ 4,929	\$ 5,419
UHWC524-SG41A	24" 5 Class Wine Refrigerator, Stainless Glass Door, RH, Locking	\$ 4,989	\$ 5,499
UHWC524-SG51A	24" 5 Class Wine Refrigerator, Stainless Glass Door, LH, Locking	\$ 4,989	\$ 5,499

See Available Door Styles on Page 12. See Available Accessories on Page 18.

5 CLASS DUAL ZONE WINE REFRIGERATORS



Features

- Independently Controlled Dual-Zones
- Industry Exclusive: Full-Depth Lower Interior Maximizes Storage Options
- Industry Leading: Variable Speed Compressor Delivers Maximum Energy Efficiency, Faster Temperature Response, and Quieter Operation
- Convection Cooling System Provides a Quick Cool Down and Consistent Temperature
- Stainless Steel Interior
- Stainless Steel Cabinet, Grille, and Accents
- U-Adjust™ Interior: 17 Adjustable Positions
- Six Removable, Full-Extension Wine Racks
- Wine Racks Accommodate a Variety of Bottle Shapes and Sizes and Can Be Configured to Store Champagne and Magnum Bottles
- Digital Touch Pad Control
- Temperature Range: (Upper Compartment) 38°F - 65°F; (Lower Compartment) 38°F - 65°F (The Upper Temperature Must Be ≥ the Lower Temperature, Maximum 20° Higher)
- Adjustable Bright White or Blue LED Lighting
- Soft Close Door With Articulating Hinges
- Volume of 5.1 Cu Ft Holds Up to 42 Wine Bottles (750 ml)
- Stainless Steel Handle (7/8" Diameter)
- Integrated Model Requires 3/4" Custom Door Panel and Handle (Not Supplied by U-Line)
- Field Reversible Door Is Shipped Right-Hand Hinged
- Built-In or Freestanding
- Floating Toe Kick Accessory Available for Seamless Integration

Dual Zone Wine Refrigerators

MODEL	DESCRIPTION	UMRP	MSRP
UHWD524-IG01A	24" 5 Class Dual Zone Wine Refrigerator, Panel Ready Glass Door	\$ 5,199	\$ 5,729
UHWD524-IS01A	24" 5 Class Dual Zone Wine Refrigerator, Panel Ready Solid Door	\$ 5,089	\$ 5,599
UHWD524-SG01A	24" 5 Class Dual Zone Wine Refrigerator, Stainless Glass Door	\$ 5,259	\$ 5,799
UHWD524-SG41A	24" 5 Class Dual Zone Wine Refrigerator, Stainless Glass Door, RH, Locking	\$ 5,339	\$ 5,869
UHWD524-SG51A	24" 5 Class Dual Zone Wine Refrigerator, Stainless Glass Door, LH, Locking	\$ 5,339	\$ 5,869

See Available Door Styles on Page 12. See Available Accessories on Page 18.

5 CLASS ACCESSORIES

Accessories

MODEL	DESCRIPTION	MAP	MSRP
ULAGRILLE15	15" Adjustable Black Grille, 5 Class	\$ 109	\$ 119
ULAGRILLE18	18" Adjustable Black Grille, 5 Class	\$ 129	\$ 149
ULAGRILLE24	24" Adjustable Black Grille, 5 Class	\$ 149	\$ 169
ULASD18BIN	18" Slide & Divide Bin Organizer, 5 Class	\$ 129	\$ 149
ULASHP15FRAME	15" Stainless Glass Door, No Handle	\$ 399	\$ 439
ULASHP15SOLID	15" Stainless Solid Door, No Handle	\$ 349	\$ 389
ULASHP18FRAME	18" Stainless Glass Door, No Handle	\$ 449	\$ 499
ULASHP18SOLID	18" Stainless Solid Door, No Handle	\$ 399	\$ 439
ULASHP24DWR	24" Stainless Solid Drawers (2), No Handles	\$ 699	\$ 769
ULASHP24FRAME	24" Stainless Glass Door, No Handle	\$ 449	\$ 499
ULASHP24SOLID	24" Stainless Solid Door, No Handle	\$ 399	\$ 439



ULASHP
Stainless Steel Door, No Handle



ULAGRILLE
Adjustable Black Grille, 5 Class

STOCK ITEMS ARE LISTED IN RED

U-LINE



UHBV524-IG01A shown with ULAGRILLE24 (Seamless Toe-Kick)

U-LINE

KNOW YOUR ICE

Crescent

- Available in a 15" widths and a variety of unique smaller sizes.
- Produces up to 25 lbs of 2 1/4" x 3/4" x 1/2" crescent per day. Stores 25 lbs.
- No drain required for easiest installation.
- Manual defrost.
- Uses less than 3 gallons of water to produce up to 25 lbs of ice.
- Daily production rate is ~4x greater than the average household refrigerator.
- R600a refrigerant – zero ozone depletion potential.
- 1 year warranty (parts & labor), 5 years (sealed system parts). 2nd year available with registration for U-Line models.



Clear

- Available in 15" & 18" widths.
- Produces up to 55 lbs of 7/8" rhomboid shaped cubes per day. Stores 25 lbs.
- Adjustable ice cube fullness. Dimple adjusts from -10 to +10. Factory setting is 0.
- Factory installed 32oz drain pump - pumps less often for industry's quietest operation.
- BrightShield antimicrobial lighting on select models.
- Easy 45 minute clean cycle.
- R600a refrigerant – zero ozone depletion potential.
- 1 year warranty (parts & labor), 5 years (sealed system parts). 2nd year available with registration.



Nugget

- Available in a 15" width.
- Produces up to 65 lbs of 1/2" x 3/8" nugget ice per day. Stores 27 lbs.
- No water filtration required.
- Factory installed 32oz drain pump - pumps less often for industry's quietest operation.
- Quiet operation, unlike the competition.
- Easy 20 minute clean cycle.
- R600a refrigerant – zero ozone depletion potential.
- U-Line indoor model panel-ready only, stainless panel accessory available.
- Bonus 2 year warranty (parts & labor), 5 years (sealed system parts).



Craft Clear

- Industry first high-capacity large clear cube machine. 15" width.
- Produces up to 160 ~2" x 2" x 1 1/4" cubes per day. Stores 25 lbs.
- Factory installed 32oz drain pump - pumps less often for industry's quietest operation.
- BrightShield Antimicrobial LED lighting.
- Easy 45 minute clean cycle.
- R600a refrigerant – zero ozone depletion potential.
- 1 year warranty (parts & labor), 5 years (sealed system parts). 2nd year available with registration.





FINDING YOUR IDEAL ICE



Crescent

25 lbs of Ice Per Day
Stores 25 lbs
Simple Functionality
No Filter Required
No Drain Required
Cube Size:
2 1/4" L x 3/4" H x 1/2" W

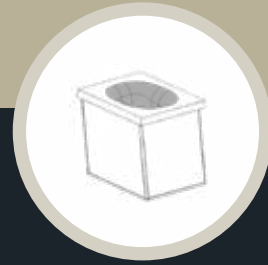

Clear

55 lbs of Ice Per Day
Stores 25 lbs
BrightShield™ LED Lighting
No Filter Required
Drain Required
Cube Size:
7/8" L x 7/8" H x 7/8" W

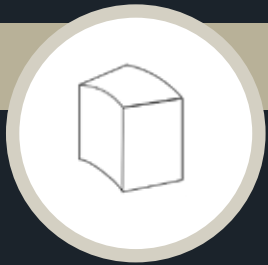

Nugget

65 lbs of Ice Per Day
Stores 27 lbs
Bright White LED Lighting
No Filter Required
No Drain Required
Cube Size:
1/2" L x 3/8" H x 5/8" W

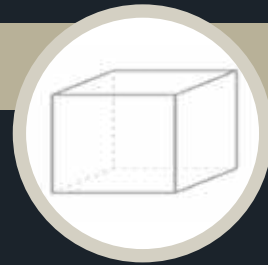

Craft Clear

160 Clear Cubes Per Day
Stores 25 lbs
BrightShield™ LED Lighting
No Filter Required
Drain Required
Cube Size:
~2" L x 1 1/4" H x 2" W

1 CLASS 15" ICE MACHINES

Crescent Ice Machine



MODEL	DESCRIPTION	MAP	MSRP
UHCR115-BS01B	15" 1 Class Ice Machine, Black Solid Door	\$ 2,579	\$ 2,829
UHCR115-IS01B	15" 1 Class Ice Machine, Panel Ready Solid Door	\$ 2,399	\$ 2,639
UHCR115-SS01B	15" 1 Class Ice Machine, Stainless Solid Door	\$ 2,579	\$ 2,829
UHCR115-WS01B	15" 1 Class Ice Machine, White Solid Door	\$ 2,579	\$ 2,829

Clear Ice Machine



MODEL	DESCRIPTION	MAP	MSRP
UHCP115-IS81A	15" 1 Class Clear Ice Machine, w/ Pump, Panel Ready Solid Door, BrightShield	\$ 2,499	\$ 2,749
UHCP115-SS81A	15" 1 Class Clear Ice Machine, w/ Pump, Stainless Solid Door, BrightShield	\$ 2,499	\$ 2,749
UHCL115-BS01A	15" 1 Class Clear Ice Machine, Black Solid Door	\$ 3,409	\$ 3,739
UHCL115-IS01A	15" 1 Class Clear Ice Machine, Panel Ready Solid Door	\$ 3,179	\$ 3,499
UHCL115-SS01A	15" 1 Class Clear Ice Machine, Stainless Solid Door	\$ 3,409	\$ 3,739
UHCL115-WS01A	15" 1 Class Clear Ice Machine, White Solid Door	\$ 3,409	\$ 3,739
UHCP115-BS01A	15" 1 Class Clear Ice Machine, w/ Pump, Black Solid Door	\$ 3,809	\$ 4,189
UHCP115-IS01A	15" 1 Class Clear Ice Machine, w/ Pump, Panel Ready Solid Door	\$ 3,679	\$ 4,059
UHCP115-SS01A	15" 1 Class Clear Ice Machine, w/ Pump, Stainless Solid Door	\$ 3,809	\$ 4,189
UHCP115-WS01A	15" 1 Class Clear Ice Machine, w/ Pump, White Solid Door	\$ 3,809	\$ 4,189

Nugget Ice Machine



MODEL	DESCRIPTION	MAP	MSRP
URNP115-IS01A	15" 1 Class Nugget Ice Machine, Panel Ready Solid Door	\$ 4,529	\$ 4,989
ULA15SPNUGGETSOLID	15" Stainless Steel Solid Door for URNP115-IS01A Ice Machine	\$ 229	\$ 259

Craft Clear Ice Machine



MODEL	DESCRIPTION	MAP	MSRP
URCC115-SS81A	15" 1 Class Craft Clear Ice Machine, w/ Pump, Stainless Solid Door, BrightShield	\$ 4,999	\$ 5,499
URCC115-IS81A	15" 1 Class Craft Clear ice Machine, w/ Pump, Panel Ready Solid Door, BrightShield	\$ 4,829	\$ 5,319

Available Door Styles



Stainless Steel



Panel Ready



Black



White

3000 SERIES 18" ICE MACHINES

MODEL	DESCRIPTION	MAP	MSRP
U-3018CLRINT-00C	18" 3000 Series Clear Ice Machine, Panel Ready Solid Door	\$ 3,929	\$ 4,319
U-3018CLRINT-40C	18" 3000 Series Clear Ice Machine, w/ Pump, Panel Ready Solid Door	\$ 4,359	\$ 4,799
U-3018CLRS-00C	18" 3000 Series Clear Ice Machine, Stainless Solid Door	\$ 4,249	\$ 4,679
U-3018CLRS-40C	18" 3000 Series Clear Ice Machine, w/ Pump, Stainless Solid Door	\$ 4,639	\$ 5,109

OUTDOOR ICE MACHINES

MODEL	DESCRIPTION	MAP	MSRP
UOCR115-SS01B	15" Outdoor Crescent Ice Machine, Stainless Solid Door	\$ 3,159	\$ 3,479
UOCL115-SS01B	15" Outdoor Clear Ice Machine, Stainless Solid Door	\$ 3,909	\$ 4,299
UOCP115-SS01B	15" Outdoor Clear Ice Machine, w/ Pump, Stainless Solid Door	\$ 4,299	\$ 4,739
UONP115-SS01C	15" Outdoor Nugget Ice Machine, Stainless Solid Door	\$ 4,899	\$ 5,389

ADA CRESCENT ICE MACHINES

MODEL	DESCRIPTION	MAP	MSRP
UACP115-IS01A	15" ADA Clear Ice Machine, w/ Pump, Panel Ready Solid Door	\$ 3,659	\$ 4,039
UACP115-SS01A	15" ADA Clear Ice Machine, w/ Pump, Stainless Solid Door	\$ 3,909	\$ 4,299
UACR115-BS01A	15" ADA Crescent Ice Machine, Black Solid Door	\$ 2,939	\$ 3,229
UACR115-SS01A	15" ADA Crescent Ice Machine, Stainless Solid Door	\$ 2,939	\$ 3,229

ADA COMPACT ICE MACHINES

MODEL	DESCRIPTION	MAP	MSRP
UACR014-BS01A	14" ADA Crescent Ice Machine, Black Solid Door	\$ 1,569	\$ 1,729
UACR014-SS01A	14" ADA Crescent Ice Machine, Stainless Solid Door	\$ 2,109	\$ 2,319
UACR014-WS01A	14" ADA Crescent Ice Machine, White Solid Door	\$ 1,569	\$ 1,729
UACR015-BS01A	15" ADA Crescent Ice Machine, Black Solid Door	\$ 1,719	\$ 1,899
UACR015-SS01A	15" ADA Crescent Ice Machine, Stainless Solid Door	\$ 1,719	\$ 1,899
UACR015-WS01A	15" ADA Crescent Ice Machine, White Solid Door	\$ 1,719	\$ 1,899

MARINE CRESCENT ICE MACHINES

MODEL	DESCRIPTION	MAP	MSRP
UMCR014-BC01A	14" Marine Crescent Ice Machine, Flange to Cabinet, Black Solid Door	\$ 1,729	\$ 1,919
UMCR014-SC01A	14" Marine Crescent Ice Machine, Flange to Cabinet, Stainless Solid Door	\$ 2,219	\$ 2,449
UMCR014-SD01A	14" Marine Crescent Ice Machine, Flange to Door, Stainless Solid Door	\$ 2,219	\$ 2,449
UMCR014-SS01A	14" Marine Crescent Ice Machine, Stainless Solid Door	\$ 2,109	\$ 2,319
UMCR014-WC01A	14" Marine Crescent Ice Machine, Flange to Cabinet, White Solid Door	\$ 1,789	\$ 1,979
UMCR015-SS01A	15" Marine Crescent Ice Machine, Stainless Solid Door	\$ 2,079	\$ 2,289
UMCR114-BC01A	14" Marine Crescent Ice Machine, Flange to Cabinet, Black Solid Door	\$ 1,909	\$ 2,099
UMCR114-SC01A	14" Marine Crescent Ice Machine, Flange to Cabinet, Stainless Solid Door	\$ 2,129	\$ 2,339
UMCR114-WC01A	14" Marine Crescent Ice Machine, Flange to Cabinet, White Solid Door	\$ 1,929	\$ 2,119

See Available Door Styles on Page 23. See Available Accessories on Page 25.

ACCESSORIES

Ice Machine Accessories

MODEL	DESCRIPTION	MAP	MSRP
ULADRAINPUMP115V	Ice Machine Drain Pump	\$ 1,299	\$ 1,429
80-55667-00	4 oz. Clear Ice Machine Cleaner	\$ 59	\$ 69
ULAFREESTANDB	24" Free Standing Kit, Black	\$ 169	\$ 189
ULAFREESTANDS	24" Free Standing Kit, Stainless	\$ 199	\$ 219
ULAWATERHOOKUP	Water Line Hook Up Kit	\$ 199	\$ 219
ULA15SPNUGGETSOLID	15" Stainless Solid Door for URNP115-IS01A Nugget Ice Machine	\$ 229	\$ 259

U-CHILL®

COOL TO THE LAST DROP

Introducing the new U-Chill and U-Chill Plus.
Customize your serving experience like never before.



U-Chill is designed to maintain the temperature of chilled wine, craft beer bomber bottles, carafes, and more. Simply touch to chill and control lighting options.

All new brushed stainless steel crown included - with the option to customize with 4 new accessory crowns that simply snap in place. Design your serving experience.



DESIGNED BY YOU

Add an accessory crown to match your hardware and your style.
Brushed stainless steel standard.
For U-Chill and U-Chill Plus.

STEP UP TO PLUS

In addition to the new U-Chill interchangeable crowns, U-Chill Plus comes with extra temperature modes and dynamic lighting.



U-LINE

U-CHILL / U-CHILL PLUS



U-Chill Features

- Control With Just a Touch
- Brushed Stainless Steel Crown Included
- New Accessory Crowns Available in Polished Stainless, Brushed Brass, Brushed Gunmetal, and Matte Black Finishes
- Powers Off Automatically After 4 Hours
- Color-Flow Setting Cycles Through the Spectrum of Colors
- Installs Into a 6-1/8" Diameter Opening in Countertops From 3/16" to 3" Thick
- Plugs Into Standard 155v / 60Hz Outlet, AC/DC Adapter Included
- Product Width: 6 3/8"
- Product Height: 11 13/16"
- Dry Cooling: Cold Jacket of Air Surrounds Your Beverage
- Optimal Ambient Temperature Range: 50°F - 90°F
- Energy Efficient
- Near-Silent Operation

U-Chill Plus Features

- 27 Different Color Options + Color Gradients
- Red Wine Mode - Keeps Red Wines at Ideal Temperature
- Boost Mode - 30 Minutes of Rapid Chilling

U-Chill / U-Chill Plus

MODEL	DESCRIPTION	MAP	MSRP
UCC1B	U-Chill® In-Counter Cooling Cylinder, Brushed Stainless	\$ 799	\$ 879
UCC2A	U-Chill® Plus In-Counter Cooling Cylinder, Brushed Stainless	\$ 899	\$ 989

U-Chill / U-Chill Plus Accessories

MODEL	DESCRIPTION	MAP	MSRP
ULACROWNSP	U-Chill® Polished Stainless Crown	\$ 69	\$ 79
ULACROWNSB	U-Chill® Brushed Stainless Crown	\$ 69	\$ 79
ULACROWNBR	U-Chill® Brushed Brass Crown	\$ 129	\$ 149
ULACROWNGM	U-Chill® Brushed Gunmetal Crown	\$ 129	\$ 149
ULACROWNMB	U-Chill® Matte Black Crown	\$ 129	\$ 149



3000 Series

- 36" Width
- Ultra-Premium Product Line with Industry-Leading Design Features
- Soft Close Hettich Articulating Hinge for Installations with Minimum Reveals
- Seamless Integration Toe Kick
- Bright White Programmable LED Lighting
- OLED Control Panel with Preset Temperature Modes
- Full Extension Wine Racks for Easy Loading and Unloading
- Beverage Center & Refrigerator Models with Bookshelf/Peg Style Adjustable Shelves
- Dual-Pane Argon Gas-Filled Glass Doors Reduce Harmful UV Rays and Increase Efficiency
- All Compressors Mounted with Rubber Grommets to Reduce Vibration, Extending Wine Storage Life and Quieter Operation
- Built-In Only

Available Door Styles



Panel Ready
Glass



Stainless Steel
Glass



Panel Ready
Solid



Stainless Steel
Solid

3000 SERIES DUAL ZONE BEVERAGE CENTERS



Features

- Convection Cooling System Provides a Quick Cool Down and Consistent Temperature
- Black Interior Is Illuminated With LED Theater Lighting and Can Be Set to Stay On for 3, 6, or 24 Hours
- LowE Coated, Argon Gas Filled, Double Thermopane Glass Door Provides Protection From Harmful UV Light
- Three Adjustable Tempered Glass Shelves
- Full-Extension, Slide-Out Crisper Drawer Is Removable for Easy Cleaning
- Wine Racks Accommodate a Variety of Bottle Shapes and Sizes; the Fourth and Fifth Racks Allow for Larger Diameter Wine and Champagne Bottles
- Full-Extension Black Coated Wine Racks
- U-Select® Control With Digital OLED Display
- Independently Controlled Dual-Zones
- Temperature Range Left: 38°F - 65°F / Right: 34°F - 70°F
- Volume of 7.0 Cu Ft Holds Up to 31 Wine Bottles (750 ml) and 79 Bottles (12 oz) or 123 Cans (12 oz)
- Stainless Steel Handles (7/8" Diameter)
- Integrated Model Requires 3/4" Custom Door Panel and Handle (Not Supplied by U-Line)
- Designed to Be Built-In (Galvanized Exterior Cabinet)
- Four Adjustable Leveling Legs
- Articulating Door Hinges
- Adjustable Grille Can Be Shifted Front-to-Back and Up-and-Down
- Grille Can Accept an Integrated Toe-Kick

Dual Zone Beverage Centers

MODEL	DESCRIPTION	MAP	MSRP
U-3036BVCINT-00B	36" 3000 Series Beverage Center, Panel Ready Glass Door	\$ 5,129	\$ 5,639
U-3036BVCINT-60B	36" 3000 Series Beverage Center, Panel Ready Solid Door	\$ 4,959	\$ 5,459
U-3036BVWCS-00B	36" 3000 Series Beverage Center, Stainless Glass Door	\$ 5,539	\$ 6,089
U-3036BVWCS-13B	36" 3000 Series Beverage Center, Stainless Glass Door, Locking	\$ 5,709	\$ 6,279

See Available Door Styles on Page 28. See Available Accessories on Page 32.

3000 SERIES DUAL ZONE REFRIGERATORS



Features

- Convection Cooling System Provides a Quick Cool Down and Consistent Temperature
- Black Interior Is Illuminated With LED Theater Lighting and Can Be Set to Stay On for 3, 6, or 24 Hours
- Each Lower Bin Is Large Enough to Fit 2 One-Gallon Containers With Additional Space for More Storage
- U-Select® Control With Digital OLED Display
- Independently Controlled Dual-Zones
- Temperature Range: 34°F to 70°F
- Volume of 6.9 Cu Ft Holds Up to 136 Bottles (12 oz) or 208 Cans (12 oz)
- Stainless Steel Handles (7/8" Diameter)
- Integrated Model Requires 3/4" Custom Door Panel and Handle (Not Supplied by U-Line)
- Designed to Be Built-In (Galvanized Exterior Cabinet)
- Four Adjustable Leveling Legs
- Articulating Door Hinges
- Adjustable Grille Can Be Shifted Front-to-Back and Up-and-Down
- Grille Can Accept an Integrated Toe-Kick

Dual Zone Refrigerators

MODEL	DESCRIPTION	MAP	MSRP
U-3036RRGLINT-00B	36" Dual Zone Refrigerator, Panel Ready Glass Door	\$ 5,139	\$ 5,649
U-3036RRGLS-00B	36" Dual Zone Refrigerator, Stainless Glass Door	\$ 5,539	\$ 6,089
U-3036RRGLS-13B	36" Dual Zone Refrigerator, Stainless Glass Door, Lock	\$ 5,659	\$ 6,229
U-3036RRINT-00B	36" Dual Zone Refrigerator, Panel Ready Solid Door	\$ 5,139	\$ 5,649
U-3036RRS-00B	36" Dual Zone Refrigerator, Stainless Solid Door	\$ 5,539	\$ 6,089

See Available Door Styles on Page 28. See Available Accessories on Page 32.

3000 SERIES DUAL ZONE WINE REFRIGERATORS



Features

- Convection Cooling System Provides a Quick Cool Down and Consistent Temperature
- Black Interior Is Illuminated With LED Theater Lighting and Can Be Set to Stay On for 3, 6, or 24 Hours
- LowE Coated, Argon Gas Filled, Double Thermopane Glass Door Provides Protection From Harmful UV Light
- Wine Racks Accommodate a Variety of Bottle Shapes and Sizes; the Fourth and Fifth Racks Allow for Larger Diameter Wine and Champagne Bottles
- Full-Extension Black Coated Wine Racks
- U-Select® Control With Digital OLED Display
- Independently Controlled Dual-Zones
- Temperature Range: 38°F to 65°F
- Volume of 7.0 Cu Ft Holds Up to 62 Wine Bottles (750 ml)
- Stainless Steel Handles (7/8" Diameter)
- Integrated Model Requires 3/4" Custom Door Panel and Handle (Not Supplied by U-Line)
- Four Adjustable Leveling Legs
- Designed to Be Built-In (Galvanized Exterior Cabinet)
- Articulating Door Hinges
- Adjustable Grille Can Be Shifted Front-to-Back and Up-and-Down
- Grille Can Accept an Integrated Toe-Kick

Dual Zone Wine Refrigerators

MODEL	DESCRIPTION	MAP	MSRP
U-3036WCWCINT-00B	36" 3000 Series Dual Zone Wine Refrigerator, Panel Ready Glass Door	\$ 5,159	\$ 5,679
U-3036WCWCINT-60B	36" 3000 Series Dual Zone Wine Refrigerator, Panel Ready Solid Door	\$ 5,019	\$ 5,529
U-3036WCWCS-00B	36" 3000 Series Dual Zone Wine Refrigerator, Stainless Glass Door	\$ 5,559	\$ 6,109
U-3036WCWCS-13B	36" 3000 Series Dual Zone Wine Refrigerator, Stainless Glass Door, Locking	\$ 5,679	\$ 6,249

See Available Door Styles on Page 28. See Available Accessories on Page 32.

ACCESSORIES

Accessories

MODEL	DESCRIPTION	MAP	MSRP
ULAGRILLE15	15" Adjustable Black Grille, 3000 Series & 5 Class	\$ 109	\$ 119
ULAGRILLE18	18" Adjustable Black Grille, 3000 Series & 5 Class	\$ 129	\$ 149
ULAGRILLE24	24" Adjustable Black Grille, 3000 Series & 5 Class	\$ 149	\$ 169
ULASD18BIN	18" Slide & Divide Bin Organizer, 3000 Series & 5 Class	\$ 129	\$ 149
ULASD24DWR	24" Slide & Divide Drawer Organizer, 2000 Series & 3000 Series	\$ 129	\$ 149
ULASHP15FRAME	15" Stainless Glass Door, No Handle	\$ 399	\$ 439
ULASHP15SOLID	15" Stainless Solid Door, No Handle	\$ 349	\$ 389
ULASHP18FRAME	18" Stainless Glass Door, No Handle	\$ 449	\$ 499
ULASHP18SOLID	18" Stainless Solid Door, No Handle	\$ 399	\$ 439
ULASHP24DWR	24" Stainless Solid Drawers (2), No Handles	\$ 699	\$ 769
ULASHP24FRAME	24" Stainless Glass Door, No Handle	\$ 449	\$ 499
ULASHP24SOLID	24" Stainless Solid Door, No Handle	\$ 399	\$ 439

See Available Door Styles on Page 12. See Available Accessories on Page 18.



2000 Series

- Premium Product Line With Industry-Leading Design Features
- 18" (45cm) and 24" (60cm) Sizes
- Zero Clearance Hettich Articulating Hinge for Installations With Tight Reveals
- Full Integration Toe Kick Option
- Field Reversible Doors (Excluding Lock Models)
- Bright White LED Lighting on All Models
- 34° to 65° Temperature Ranges (Varies Slightly by Model) – Dairy & Wine Safe
- Wine Units Offer Full Extension Coated Racks for Easy Loading and Unloading
- Beverage Center & Refrigerator Models Offer Bookshelf/Peg Style Adjustable Shelves
- Dual-Pane Argon Gas Filled Glass Doors Reduce Harmful UV Rays and Increase Efficiency
- All Compressors Mounted With Rubber Grommets to Reduce Vibration, Extending Wine Storage Life and Quieter Operation
- Built-In Only (Galvanized Cabinet)

Available Door Styles



Panel Ready Glass

Panel Ready Solid

Stainless Steel Glass

Stainless Steel Solid

Panel Ready Drawers

Stainless Steel Drawers

2000 SERIES BEVERAGE CENTERS



Features

- Convection Cooling System Provides a Quick Cool Down and Consistent Temperature
- Black Interior Is Illuminated With LED Lighting and Can Be Set to Stay On for 3 Hours
- LowE Coated, Argon Gas Filled, Double Thermopane Glass Door Provides Protection From Harmful UV Light
- Three Adjustable Tempered Glass Shelves
- Wine Racks Accommodate a Variety of Bottle Shapes and Sizes
- Full-Extension Black Coated Wine Racks
- Digital Touch Pad Control
- Temperature Range: 34°F to 45°F
- Volume of 4.9 Cu Ft Holds Up to 10 Wine Bottles (750 ml) and 79 Bottles (12 oz) or 123 Cans (12 oz)
- Stainless Steel Handle (7/8" Diameter)
- Integrated Model Requires 3/4" Custom Door Panel and Handle (Not Supplied by U-Line)
- Field Reversible Door Is Shipped Right-Hand Hinged
- Designed for Built-In Applications (Galvanized Exterior Cabinet)
- Four Adjustable Leveling Legs
- Articulating Door Hinges
- Lock Models Must Be Ordered Right-Hand or Left-Hand Hinged
- Grille Can Accept an Integrated Toe-Kick

Beverage Centers

MODEL	DESCRIPTION	MAP	MSRP
U-2218BEVINT-00A	18" 2000 Series Beverage Center, Panel Ready Glass Door	\$ 2,929	\$ 3,219
U-2218BEVINT-60A	18" 2000 Series Beverage Center, Panel Ready Solid Door	\$ 2,829	\$ 3,119
U-2218BEVS-00A	18" 2000 Series Beverage Center, Stainless Glass Door	\$ 3,149	\$ 3,469
U-2218BEVS-13A	18" 2000 Series Beverage Center, Stainless Glass Door, RH, Locking	\$ 3,199	\$ 3,519
U-2218BEVS-15A	18" 2000 Series Beverage Center, Stainless Glass Door, LH, Locking	\$ 3,199	\$ 3,519
U-2224BEVINT-00B	24" 2000 Series Beverage Center, Panel Ready Glass Door	\$ 2,939	\$ 3,229
U-2224BEVINT-60B	24" 2000 Series Beverage Center, Panel Ready Solid Door	\$ 2,849	\$ 3,149
U-2224BEVS-00B	24" 2000 Series Beverage Center, Stainless Glass Door	\$ 3,149	\$ 3,469
U-2224BEVS-13B	24" 2000 Series Beverage Center, Stainless Glass Door, RH, Locking	\$ 3,229	\$ 3,569
U-2224BEVS-15B	24" 2000 Series Beverage Center, Stainless Glass Door, LH, Locking	\$ 3,229	\$ 3,569

See Available Door Styles on Page 33. See Available Accessories on Page 38.

2000 SERIES REFRIGERATORS



Features

- Convection Cooling System Provides a Quick Cool Down and Consistent Temperature
- Black Interior
- LowE Coated, Argon Gas Filled, Double Thermopane Glass Door Provides Protection From Harmful UV Light
- Three Adjustable Tempered Glass Shelves
- Full-Extension, Slide-Out Crisper Drawer Is Removable for Easy Cleaning
- Digital Touch Pad Control
- Temperature Range: 34°F to 45°F
- Bright White LED Lighting
- Volume of 4.9 Cu Ft Holds Up to 114 Bottles (12 oz) or 172 Cans (12 oz)
- Stainless Steel Handle (7/8" Diameter)
- Integrated Model Requires 3/4" Custom Door Panel and Handle (Not Supplied by U-Line)
- Field Reversible Door Is Shipped Right-Hand Hinged
- Four Adjustable Leveling Legs
- Articulating Door Hinges
- Lock Models Must Be Ordered Right-Hand or Left-Hand Hinged
- Grille Can Accept an Integrated Toe-Kick
- Designed for Built-In Applications (Galvanized Exterior Cabinet)

Refrigerators

MODEL	DESCRIPTION	MAP	MSRP
U-2218RGLINT-00B	18" 2000 Series Refrigerator, Panel Ready Glass Door	\$ 2,739	\$ 3,019
U-2218RGLS-00B	18" 2000 Series Refrigerator, Stainless Glass Door	\$ 2,959	\$ 3,249
U-2218RINT-00B	18" 2000 Series Refrigerator, Panel Ready Solid Door	\$ 2,729	\$ 3,009
U-2218RS-00B	18" 2000 Series Refrigerator, Stainless Solid Door	\$ 2,939	\$ 3,229
U-2224RGLINT-00B	24" 2000 Series Refrigerator, Panel Ready Glass Door	\$ 3,039	\$ 3,349
U-2224RGLS-00B	24" 2000 Series Refrigerator, Stainless Glass Door	\$ 3,249	\$ 3,589
U-2224RGLS-13B	24" 2000 Series Refrigerator, Stainless Glass Door, RH, Locking	\$ 3,319	\$ 3,659
U-2224RGLS-15B	24" 2000 Series Refrigerator, Stainless Glass Door, LH, Locking	\$ 3,319	\$ 3,659
U-2224RINT-00B	24" 2000 Series Refrigerator, Panel Ready Solid Door	\$ 2,869	\$ 3,159
U-2224RS-00B	24" 2000 Series Refrigerator, Stainless Solid Door	\$ 3,079	\$ 3,399
U-2224DWPRINT-00A	24" 2000 Series Refrigerator Drawers, Panel Ready Solid Door	\$ 4,139	\$ 4,559
U-2224DWRS-00A	24" 2000 Series Refrigerator Drawers, Stainless Solid Door	\$ 4,399	\$ 4,829

See Available Door Styles on Page 33. See Available Accessories on Page 38.

2000 SERIES SINGLE ZONE WINE REFRIGERATORS



Features

- Convection Cooling System Provides a Quick Cool Down and Consistent Temperature
- Black Interior Is Illuminated With LED Lighting and Can Be Set to Stay On for 3 Hours
- LowE Coated, Argon Gas Filled, Double Thermopane Glass Door Provides Protection From Harmful UV Light
- Wine Racks Accommodate a Variety of Bottle Shapes and Sizes; the Fourth and Fifth Racks Allow for Larger Diameter Wine and Champagne Bottles
- Full-Extension Black Coated Wine Racks
- Digital Touch Pad Control
- Temperature Range: 38°F to 65°F
- Volume of 4.7 Cu Ft Holds Up to 43 Wine Bottles (750 ml)
- Stainless Steel Handle (7/8" Diameter)
- Integrated Model Requires 3/4" Custom Door Panel and Handle (Not Supplied by U-Line)
- Field Reversible Door Is Shipped Right-Hand Hinged
- Four Adjustable Leveling Legs
- Designed for Built-In Applications (Galvanized Exterior Cabinet)
- Articulating Door Hinges
- Lock Models Must Be Ordered Right-Hand or Left-Hand Hinged
- Grille Can Accept an Integrated Toe-Kick

Refrigerators

MODEL	DESCRIPTION	MAP	MSRP
U-2218WCINT-00B	18" 2000 Series Wine Refrigerator, Panel Ready Glass Door	\$ 3,319	\$ 3,659
U-2218WCS-00B	18" 2000 Series Wine Refrigerator, Panel Ready Solid Door	\$ 3,579	\$ 3,939
U-2224WCINT-00A	24" 2000 Series Wine Refrigerator, Panel Ready Glass Door	\$ 3,489	\$ 3,839
U-2224WCINT-60A	24" 2000 Series Wine Refrigerator, Panel Ready Solid Door	\$ 3,259	\$ 3,599
U-2224WCS-00A	24" 2000 Series Wine Refrigerator, Stainless Glass Door	\$ 3,609	\$ 3,969
U-2224WCS-13A	24" 2000 Series Wine Refrigerator, Stainless Glass Door, RH, Locking	\$ 3,669	\$ 4,049
U-2224WCS-15A	24" 2000 Series Wine Refrigerator, Stainless Glass Door, LH, Locking	\$ 3,669	\$ 4,049

See Available Door Styles on Page 33. See Available Accessories on Page 38.

2000 SERIES DUAL ZONE WINE REFRIGERATORS



Features

- Black Interior Is Illuminated With LED Lighting and Can Be Set to Stay On for 3 Hours
- LowE Coated, Argon Gas Filled, Double Thermopane Glass Door Provides Protection From Harmful UV Light
- Wine Racks Accommodate a Variety of Bottle Shapes and Sizes; the Third and Sixth Racks Allow for Larger Diameter Wine and Champagne Bottles
- Full-Extension Black Coated Wine Racks
- Digital Touch Pad Control
- Independently Controlled Dual-Zones
- Temperature Range: 38°F to 65°F
- Volume of 4.7 Cu Ft Holds Up to 43 Wine Bottles (750 ml)
- Stainless Steel Handle (7/8" Diameter)
- Integrated Model Requires 3/4" Custom Door Panel and Handle (Not Supplied by U-Line)
- Field Reversible Door Is Shipped Right-Hand Hinged
- Four Adjustable Leveling Legs
- Designed for Built-In Applications (Galvanized Exterior Cabinet)
- Articulating Door Hinges
- Lock Models Must Be Ordered Right-Hand or Left-Hand Hinged
- Grille Can Accept an Integrated Toe-Kick

Refrigerators

MODEL	DESCRIPTION	MAP	MSRP
U-2224ZWCINT-00B	24" 2000 Series Dual Zone Wine Refrigerator, Panel Ready Glass Door	\$ 4,169	\$ 4,589
U-2224ZWCINT-60B	24" 2000 Series Dual Zone Wine Refrigerator, Panel Ready Solid Door	\$ 4,079	\$ 4,489
U-2224ZWCS-00B	24" 2000 Series Dual Zone Wine Refrigerator, Stainless Glass Door	\$ 4,509	\$ 4,959
U-2224ZWCS-13B	24" 2000 Series Dual Zone Wine Refrigerator, Stainless Glass Door, RH, Locking	\$ 4,579	\$ 5,039
U-2224ZWCS-15B	24" 2000 Series Dual Zone Wine Refrigerator, Stainless Glass Door, LH, Locking	\$ 4,579	\$ 5,039

See Available Door Styles on Page 33. See Available Accessories on Page 38.

ACCESSORIES

Accessories

MODEL	DESCRIPTION	MAP	MSRP
ULASD24DWR	24" Slide & Divide Drawer Organizer, 2000 Series & 3000 Series	\$ 129	\$ 149
ULASHP15FRAME	15" Stainless Glass Door, No Handle	\$ 399	\$ 439
ULASHP15SOLID	15" Stainless Solid Door, No Handle	\$ 349	\$ 389
ULASHP18FRAME	18" Stainless Glass Door, No Handle	\$ 449	\$ 499
ULASHP18SOLID	18" Stainless Solid Door, No Handle	\$ 399	\$ 439
ULASHP24DWR	24" Stainless Solid Drawers (2), No Handles	\$ 699	\$ 769
ULASHP24FRAME	24" Stainless Glass Door, No Handle	\$ 449	\$ 499
ULASHP24SOLID	24" Stainless Solid Door, No Handle	\$ 399	\$ 439



1 Class Series

- Mass premium with competitive price points, features & design, and offer the broadest range of product options.
- 15" and 24" widths.
- Field reversible doors (including lock models).
- Bright white LED lighting on all models.
- 34° to 60° temperature ranges on all models – dairy & wine safe.
- 24" models feature an extended lower interior allowing for 2L sodas, 1.5L magnum wine bottles and 750ML wine bottles.
- Wine units offer ¾ extension, coated racks for easy loading and unloading.
- Dual-pane argon gas filled glass doors reduce harmful UV's and increase efficiency.
- All compressors are mounted with rubber grommets to reduce vibration extending wine storage life and quieter operation.

Available Door Styles



Panel Ready Glass



Panel Ready Solid



Stainless Steel Glass



Stainless Steel Solid



Panel Ready Glass



Panel Ready Solid



Black Glass



Black Solid



White Solid

1 CLASS BEVERAGE CENTERS



Features

- Convection Cooling System Provides a Quick Cool Down and Consistent Temperature
- Extended Lower Interior Maximizes Storage Options
- Black Interior
- LowE Coated, Argon Gas Filled, Dual Thermopane Glass Door Provides Protection from Harmful UV Light
- Stainless Steel Grille and Full-Wrap Door
- Three Adjustable Tempered Glass Shelves
- Digital Touch Pad Control
- Temperature Range: 34°F to 60°F
- Bright White LED Lighting
- Volume of 5.7 Cu Ft Holds Up to 6 Wine Bottles (750 ml) and 117 Bottles (12 oz) or 194 Cans (12 oz)
- Stainless Steel Handle (7/8" Diameter)
- Field Reversible Door is Shipped Right-Hand Hinged
- Built-In or Freestanding
- Four Adjustable Leveling Legs

Beverage Centers

MODEL	DESCRIPTION	MAP	MSRP
UHBV024-SG01A	24" 1 Class Beverage Center, Stainless Glass Door	\$ 1,729	\$ 1,919
UHBV024-SS01A	24" 1 Class Beverage Center, Stainless Solid Door	\$ 1,659	\$ 1,819

See Available Door Styles on Page 39. See Available Accessories on Page 48.

1 CLASS BEVERAGE CENTERS



Features

- Convection Cooling System Provides a Quick Cool Down and Consistent Temperature
- Extended Lower Interior Maximizes Storage Options
- Black Interior
- LowE Coated, Argon Gas Filled, Dual Thermopane Glass Door Provides Protection from Harmful UV Light
- Stainless Steel Full-Wrap Door and Handle (7/8" Diameter)
- Stainless Steel Grille (Stainless Model), Black Metal Grille (Integrated Models)
- Two Three-Quarter Extension Black Wine Racks
- Two Adjustable Tempered Glass Shelves
- Digital Touch Pad Control
- Temperature Range: 34°F to 60°F
- Bright White LED Lighting
- 24" — Volume of 5.5 Cu Ft Holds Up to 16 Wine Bottles (750 ml) and 85 Bottles (12 oz) or 105 Cans (12 oz)
- 15" — Volume of 2.9 Cu Ft Holds Up to 8 Wine Bottles (750 ml) and 48 Bottles (12 oz) or 60 Cans (12 oz)
- Field Reversible Door is Shipped Right-Hand Hinged
- Built-In or Freestanding
- Four Adjustable Leveling Legs

Beverage Centers

MODEL	DESCRIPTION	MAP	MSRP
UHBV115-IG01A	15" 1 Class Beverage Center, Panel Ready Glass Door	\$ 2,039	\$ 2,239
UHBV115-IS01A	15" 1 Class Beverage Center, Panel Ready Solid Door	\$ 1,929	\$ 2,119
UHBV115-SG01A	15" 1 Class Beverage Center, Stainless Glass Door	\$ 2,109	\$ 2,319
UHBV124-IG01A	24" 1 Class Beverage Center, Panel Ready Glass Door	\$ 2,189	\$ 2,419
UHBV124-IS01A	24" 1 Class Beverage Center, Panel Ready Solid Door	\$ 2,049	\$ 2,259
UHBV124-SG01A	24" 1 Class Beverage Center, Stainless Glass Door	\$ 2,239	\$ 2,469
UHBV124-SG31A	24" 1 Class Beverage Center, Stainless Glass Door, Locking	\$ 2,309	\$ 2,549

See Available Door Styles on Page 39. See Available Accessories on Page 48.







1 CLASS REFRIGERATORS



Features

- Convection Cooling System Provides a Quick Cool Down and Consistent Temperature
- Extended Lower Interior Maximizes Storage Options
- Black Interior
- LowE Coated, Argon Gas Filled, Dual Thermopane Glass Door Provides Protection From Harmful UV Light
- Stainless Steel Full-Wrap Door and Handle (7/8" Diameter)
- Stainless Steel Grille (Stainless Model), Black Metal Grille (Black, White, and Integrated Models)
- Three Adjustable Tempered Glass Shelves
- One Slide-Out Black Metal Shelf
- Digital Touch Pad Control
- Temperature Range: 34°F to 60°F
- BrightShield™ Available on Select Models 
- Bright White LED Lighting
- 15" Volume of 3.1 Cu Ft Holds Up to 57 Bottles (12 oz) or 92 Cans (12 oz)
- 24" Volume of 5.7 Cu Ft Holds Up to 123 Bottles (12 oz) or 185 Cans (12 oz)
- Field Reversible Door Is Shipped Right-Hand Hinged
- Built-In or Freestanding
- Four Adjustable Leveling Legs

Refrigerators

MODEL	DESCRIPTION	MAP	MSRP
UHRE115-BS01A	15" 1 Class Refrigerator, Black Solid Door	\$ 2,119	\$ 2,329
UHRE115-IS01A	15" 1 Class Refrigerator, Panel Ready Solid Door	\$ 1,999	\$ 2,199
UHRE115-SS01A	15" 1 Class Refrigerator, Stainless Solid Door	\$ 2,119	\$ 2,329
 UHRE124-BS81A	24" 1 Class Refrigerator, Black Solid Door, BrightShield	\$ 2,419	\$ 2,659
 UHRE124-IG81A	24" 1 Class Refrigerator, Panel Ready Glass Door, BrightShield	\$ 2,469	\$ 2,719
 UHRE124-IS81A	24" 1 Class Refrigerator, Panel Ready Solid Door, BrightShield	\$ 2,359	\$ 2,589
 UHRE124-SG81A	24" 1 Class Refrigerator, Stainless Glass Door, BrightShield	\$ 2,539	\$ 2,789
 UHRE124-SS81A	24" 1 Class Refrigerator, Stainless Solid Door, BrightShield	\$ 2,419	\$ 2,659
 UHRE124-WS81A	24" 1 Class Refrigerator, White Solid Door, BrightShield	\$ 2,419	\$ 2,659
UHRE124-BS01A	24" 1 Class Refrigerator, Black Solid Door	\$ 2,199	\$ 2,429
UHRE124-IG01A	24" 1 Class Refrigerator, Panel Ready Glass Door	\$ 2,249	\$ 2,479
UHRE124-IS01A	24" 1 Class Refrigerator, Panel Ready Solid Door	\$ 2,139	\$ 2,359
UHRE124-SG01A	24" 1 Class Refrigerator, Stainless Glass Door	\$ 2,319	\$ 2,559
UHRE124-SS01A	24" 1 Class Refrigerator, Stainless Solid Door	\$ 2,199	\$ 2,429
UHRE124-WS01A	24" 1 Class Refrigerator, White Solid Door	\$ 2,199	\$ 2,429
UHDR124-IS61A	24" 1 Class Refrigerator Drawers, Panel Ready Solid Door	\$ 3,629	\$ 3,999
UHDR124-SS61A	24" 1 Class Refrigerator Drawers, Stainless Solid Door	\$ 3,749	\$ 4,129

See Available Door Styles on Page 39. See Available Accessories on Page 48.

1 CLASS COMBO REFRIGERATOR FREEZER



Features

- Refrigerator Volume of 4.2 Cu Ft + 1.5 Cu Ft Holds Up to 61 Bottles (12 oz) or 114 Cans (12 oz)
- Freezer Volume of 1.5 Cu Ft
- Digital Touch Pad Control
- Refrigerator Temperature Range: 34°F to 45°F
- Frost-Free Freezer
- White Interior Is Illuminated With LED Lighting
- Three Removable Tempered Glass Shelves
- Stainless Steel Handle (7/8" Diameter)
- Integrated Model Requires 3/4" Custom Door Panel and Handle (Not Supplied by U-Line)
- Field Reversible Door Is Shipped Right-Hand Hinged
- Built-In or Freestanding
- 4 Adjustable Leveling Legs

Refrigerator/Freezers

MODEL	DESCRIPTION	MAP	MSRP
UHRF124-BS01A	24" 1 Class Refrigerator Freezer, Black Solid Door	\$ 2,779	\$ 3,059
UHRF124-IS01A	24" 1 Class Refrigerator Freezer, Panel Ready Solid Door	\$ 2,579	\$ 2,829
UHRF124-SS01A	24" 1 Class Refrigerator Freezer, Stainless Solid Door	\$ 2,779	\$ 3,059
UHRF124-WS01A	24" 1 Class Refrigerator Freezer, White Solid Door	\$ 2,779	\$ 3,059

See Available Door Styles on Page 39. See Available Accessories on Page 48.

1 CLASS COMBO REFRIGERATOR ICE MAKER



Features

- Refrigerator Volume of 4.2 Cu Ft Holds Up to 61 Bottles (12 oz) or 114 Cans (12 oz)
- Digital Touch Pad Control
- Refrigerator Temperature Range: 34°F to 45°F
- Produces and Stores Up to 8 Lb of Ice Per Day
- Crescent Ice Cube Dimensions: 1/2" W x 3/4" H x 2 1/4" L
- White Interior Is Illuminated With LED Lighting
- Three Removable Tempered Glass Shelves
- No Drain Required
- Stainless Steel Handle (7/8" Diameter)
- Integrated Model Requires 3/4" Custom Door Panel and Handle (Not Supplied by U-Line)
- Field Reversible Door Is Shipped Right-Hand Hinged
- Built-In or Freestanding
- 4 Adjustable Leveling Legs

Refrigerator/Ice Maker

MODEL	DESCRIPTION	MAP	MSRP
UHR124-BS01A	24" 1 Class Refrigerator w/ Ice, Black Solid Door	\$ 2,889	\$ 3,179
UHR124-IS01A	24" 1 Class Refrigerator w/ Ice, Panel Ready Solid Door	\$ 2,779	\$ 3,059
UHR124-SS01A	24" 1 Class Refrigerator w/ Ice, Stainless Solid Door	\$ 2,889	\$ 3,179
UHR124-WS01A	24" 1 Class Refrigerator w/ Ice, White Solid Door	\$ 2,889	\$ 3,179

See Available Door Styles on Page 39. See Available Accessories on Page 48.

1 CLASS CONVERTIBLE FREEZER



Features

- Converts to a Refrigerator with the Touch of a Button
- Convection Cooling System Provides a Quick Cool Down and Consistent Temperature
- White Interior
- Stainless Steel Full-Wrap Door and Handle (7/8" Diameter)
- Stainless Steel Grille (Stainless Model), Black Metal Grille (Integrated Model)
- Three Full-Extension Chrome-Plated Slide-Out Baskets
- Digital Touch Pad Control
- Refrigerator Temperature Range: 34°F to 45°F
- Freezer Temperature Range: -5°F to 5°F
- Bright White LED Lighting
- Volume of 4.8 Cu Ft
- Field Reversible Door is Shipped Right-Hand Hinged
- Built-In or Freestanding
- Four Adjustable Leveling Legs

Convertible Freezer

MODEL	DESCRIPTION	MAP	MSRP
UHFZ124-IS01B	24" 1 Class Freezer, Panel Ready Solid Door	\$ 2,979	\$ 3,269
UHFZ124-SS01B	24" 1 Class Freezer, Stainless Solid Door	\$ 3,109	\$ 3,439

See Available Door Styles on Page 39. See Available Accessories on Page 48.

1 CLASS WINE REFRIGERATORS



Features

- Convection Cooling System Provides a Quick Cool Down and Consistent Temperature
- Extended Lower Interior Maximizes Storage Options
- Black Interior
- LowE Coated, Argon Gas Filled, Dual Thermopane Glass Door Provides Protection from Harmful UV Light
- Stainless Steel Grille and Full-Wrap Door
- Four Fixed Black Wine Racks
- Wine Racks Accommodate a Variety of Bottle Sizes, Including Champagne and Magnum Bottles
- Digital Touch Pad Control
- Temperature Range: 34°F to 60°F
- Bright White LED Lighting
- Volume of 5.4 Cu Ft Holds Up to 38 Wine Bottles (750 ml)
- Stainless Steel Handle (7/8" Diameter)
- Field Reversible Door is Shipped Right-Hand Hinged
- Built-In or Freestanding
- Four Adjustable Leveling Legs

Wine Refrigerators

MODEL	DESCRIPTION	MAP	MSRP
UHWC024-SG01A	24" 1 Class Wine Refrigerator, Stainless Glass Door	\$ 1,959	\$ 2,159

See Available Door Styles on Page 39. See Available Accessories on Page 48.

1 CLASS WINE REFRIGERATORS



Features

- Convection Cooling System Provides a Quick Cool Down and Consistent Temperature
- Extended Lower Interior Maximizes Storage Options
- Black Interior
- LowE Coated, Argon Gas Filled, Dual Thermopane Glass Door Provides Protection from Harmful UV Light
- Stainless Steel Full-Wrap Door and Handle (7/8" Diameter)
- Stainless Steel Grille (Stainless Model) and Black Metal Grille (Black and Integrated Models)
- Five Three-Quarter Extension Black Wine Racks
- Digital Touch Pad Control
- Temperature Range: 34°F to 60°F
- Bright White LED Lighting
- Volume: 5.5 Cu Ft Holds Up to 48 Wine Bottles (750 ml)
- Field Reversible Door Is Shipped Right-Hand Hinged
- Built-In or Freestanding
- Four Adjustable Leveling Legs

Wine Refrigerators

MODEL	DESCRIPTION	MAP	MSRP
UHWC115-BG01A	15" 1 Class Wine Refrigerator, Black Glass Door	\$ 2,439	\$ 2,679
UHWC115-IG01A	15" 1 Class Wine Refrigerator, Panel Ready Glass Door	\$ 2,369	\$ 2,599
UHWC115-IS01A	15" 1 Class Wine Refrigerator, Panel Ready Solid Door	\$ 2,239	\$ 2,469
UHWC115-SG01A	15" 1 Class Wine Refrigerator, Stainless Glass Door	\$ 2,439	\$ 2,679
UHWC124-BG01A	24" 1 Class Wine Refrigerator, Black Glass Door	\$ 2,579	\$ 2,829
UHWC124-IG01A	24" 1 Class Wine Refrigerator, Panel Ready Glass Door	\$ 2,529	\$ 2,779
UHWC124-IS01A	24" 1 Class Wine Refrigerator, Panel Ready Solid Door	\$ 2,399	\$ 2,639
UHWC124-SG01A	24" 1 Class Wine Refrigerator, Stainless Glass Door	\$ 2,579	\$ 2,829
UHWC124-SG31A	24" 1 Class Wine Refrigerator, Stainless Glass Door, Locking	\$ 2,649	\$ 2,929

See Available Door Styles on Page 39. See Available Accessories on Page 48.

ACCESSORIES

Accessories

MODEL	DESCRIPTION	MAP	MSRP
ULASHP15FRAME	15" Stainless Glass Door, No Handle	\$ 399	\$ 439
ULASHP15SOLID	15" Stainless Solid Door, No Handle	\$ 349	\$ 389
ULASHP18FRAME	18" Stainless Glass Door, No Handle	\$ 449	\$ 499
ULASHP18SOLID	18" Stainless Solid Door, No Handle	\$ 399	\$ 439
ULASHP24DWR	24" Stainless Solid Drawers (2), No Handles	\$ 699	\$ 769
ULASHP24FRAME	24" Stainless Glass Door, No Handle	\$ 449	\$ 499
ULASHP24SOLID	24" Stainless Solid Door, No Handle	\$ 399	\$ 439



Outdoor Collection

Entertain in the open air. Serve signature beverages over ice, pour freshly tapped beer, and store chilled ingredients in your prep area ready for grilling. With robust stainless steel components & accents, our new collection of outdoor products provide best-in-class performance and showcase clean, modern designs fit for the outdoors.

- 15" & 24" Refrigerators
- 24" Drawer Refrigerator
- 24" Freezer
- 24" Keg Refrigerator
- Ice Machines (Page 22)

Available Door Styles



Stainless Steel
Solid



Stainless Steel
Drawers



Stainless Steel
Solid with Tap

OUTDOOR REFRIGERATOR



Features

- Convection Cooling System Provides a Quick Cool Down and Consistent Temperature
- Extended Lower Interior Maximizes Storage Options
- White Interior
- Stainless Steel Cabinet, Grille, and Full-Wrap Door
- Three Adjustable Tempered Glass Shelves
- Digital Touch Pad Control
- Temperature Range: 34°F to 60°F
- Bright White LED Lighting
- Volume of 5.4 Cu Ft Holds Up to 117 Bottles (12 oz) or 194 Cans (12 oz)
- Stainless Steel Handle (7/8" Diameter)
- Field Reversible Door Is Shipped Right-Hand Hinged
- Built-In or Freestanding
- Four Adjustable Leveling Legs

Refrigerator

MODEL	DESCRIPTION	MAP	MSRP
UORE115-SS01A	15" Outdoor Refrigerator, Stainless Solid Door	\$ 2,909	\$ 3,209
UORE115-SS31A	15" Outdoor Refrigerator, Stainless Solid Door, Locking	\$ 2,979	\$ 3,269
UORE124-SS01A	24" Outdoor Refrigerator, Stainless Solid Door	\$ 3,059	\$ 3,379
UORE124-SS31A	24" Outdoor Refrigerator, Stainless Solid Door, Locking	\$ 3,139	\$ 3,459
UODR124-SS61A	24" Outdoor Refrigerator Drawers, Stainless Solid Door	\$ 4,429	\$ 4,869

See Available Door Styles on Page 49. See Available Accessories on Page 61.

OUTDOOR CONVERTIBLE FREEZER



Features

- Converts to a Refrigerator With the Touch of a Button
- Convection Cooling System Provides a Quick Cool Down and Consistent Temperature
- White Interior
- Stainless Steel Cabinet, Grille, and Full-Wrap Door
- Three Full-Extension Chrome Plated Slide-Out Baskets
- Digital Touch Pad Control
- Refrigerator Temperature Range: -5°F to 5°F / 33°F to 70°F
- Freezer Temperature Range: -5°F to 5°F
- Bright White LED Lighting
- Volume of 4.9 Cu Ft Holds Up to Bottles (12 oz) or Cans (12 oz)
- Stainless Steel Handle (7/8" Diameter)
- Field Reversible Door Is Shipped Right-Hand Hinged
- Built-In or Freestanding
- Four Adjustable Leveling Legs

Convertible Freezer

MODEL	DESCRIPTION	MAP	MSRP
UOFZ124-SS01B	24" Outdoor Freezer, Stainless Solid Door	\$ 3,689	\$ 4,069

See Available Door Styles on Page 49. See Available Accessories on Page 61.

OUTDOOR BEVERAGE DISPENSER



Features

- Convection Cooling System Provides a Quick Cool Down and Consistent Temperature
- White Interior
- Removable Lower Interior Stainless Steel Liner
- Stainless Steel Cabinet, Grille, and Full-Wrap Door
- Two Adjustable Chrome Plated Wire Shelves
- Digital Touch Pad Control
- Temperature Range: 34°F to 60°F
- Bright White LED Lighting
- Volume of 5.6 Cu Ft Can Fit Up to One 1/4 Slim Barrel and One 1/6 Barrel or One Standard 1/4 Barrel
- Holds Up to 111 Bottles (12 oz) or 165 Cans (12 oz)
- Stainless Steel Handle (7/8" Diameter)
- Field Reversible Door Is Shipped Right-Hand Hinged
- Built-In or Freestanding
- Four Adjustable Leveling Legs
- Accessory Tap Tower Kits Sold Separately
- Accessory Tap Tower Kits Include: Low Profile Tap Head(s), CO2 Tank and Regulator, Tubing and Clamps, Mounting Hardware, Black Tap Handle(s), Drip Tray, and Cleaning Kit

Beverage Dispenser

MODEL	DESCRIPTION	MAP	MSRP
UOKR124-SS01A	24" Outdoor Beverage Dispenser, Stainless Solid Door	\$ 3,199	\$ 3,519

Beverage Dispenser Accessories

MODEL	DESCRIPTION	MAP	MSRP
ULATAPDOUBLE	Double Tapper Kit	\$ 1,299	\$ 1,429
ULATAPSINGLE	Single Tapper Kit	\$ 999	\$ 1,099

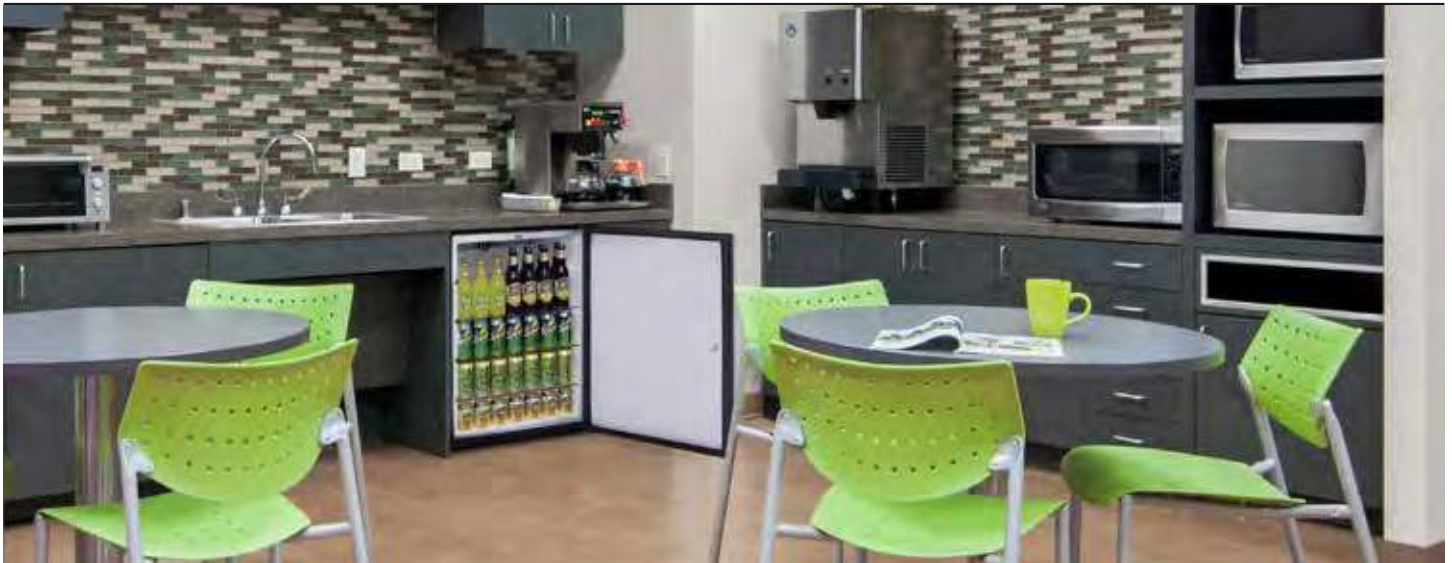

ADA Collection

Modern ice and refrigeration solutions for installations under 34" countertops. Our wide collection of ADA height compliant products are easily accessible and allow for single-hand operation. Perfect for offices, break rooms, hotels, and kitchens requiring appliances no higher than 32".

- 21" & 24" Refrigerators (4 models)
- Ice Machines (Page 22)
- Field reversible doors (including lock models).
- Bright white LED lighting on all models.
- 34° to 45° temperature ranges on all models – dairy safe.

Available Door Styles



Panel Ready Glass



Panel Ready Solid



Stainless Steel Glass



Stainless Steel Solid



Black Glass



Black Solid



White Solid

ADA COMPACT REFRIGERATOR



Features

- Meets ADA Height Requirement
- Three Fixed Door Storage Compartments
- Three Removable Tempered Glass Shelves
- Mechanical Dial Control
- Approximate Temperature Range: ~34°F to 45°F
- Volume of 3.3 Cu Ft Holds Up to 35 Bottles (12 oz) or 48 Cans (12 oz)
- Field Reversible Door is Shipped Right-Hand Hinged
- Built-In or Freestanding
- Lock Models Must Be Ordered Right-Hand or Left-Hand Hinged

Compact Refrigerator

MODEL	DESCRIPTION	MAP	MSRP
U-29RB-00A	21" ADA Refrigerator, Black Solid Door	\$ 1,649	\$ 1,809
U-29RB-13A	21" ADA Refrigerator, Black Solid Door, RH, Locking	\$ 1,709	\$ 1,889
U-29RB-15A	21" ADA Refrigerator, Black Solid Door, LH, Locking	\$ 1,709	\$ 1,889
U-29RW-00A	21" ADA Refrigerator, White Solid Door	\$ 1,649	\$ 1,809
U-29RW-13A	21" ADA Refrigerator, White Solid Door, RH, Locking	\$ 1,709	\$ 1,889
U-29RW-15A	21" ADA Refrigerator, White Solid Door, LH, Locking	\$ 1,709	\$ 1,889

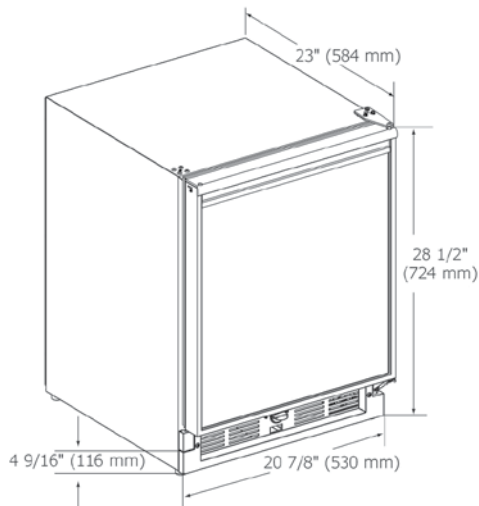

See Available Door Styles on Page 53. See Available Accessories on Page 61.

ADA REFRIGERATOR



Features

- Convection Cooling System Provides a Quick Cool Down and Consistent Temperature
- Meets ADA Height Requirement
- White Interior
- Three Removable Tempered Glass Shelves
- Digital Touch Pad Control
- Temperature Range: 34°F to 45°F
- Bright White LED Lighting
- Volume of 5.3 Cu Ft Holds Up to 70 Bottles (12 oz) or 140 Cans (12 oz)
- Stainless Steel Handle (7/8" Diameter)
- Integrated Model Requires 3/4" Custom Door Panel and Handle (Not Supplied by U-Line)
- Field Reversible Door is Shipped Right-Hand Hinged
- Built-In or Freestanding
- Four Adjustable Leveling Legs

Refrigerator

MODEL	DESCRIPTION	MAP	MSRP
U-ADA24RB-13B	24" ADA Refrigerator, Black Solid Door, Locking	\$ 2,769	\$ 3,049
U-ADA24RGLB-13B	24" ADA Refrigerator, Black Glass Door, Locking	\$ 2,959	\$ 3,249
U-ADA24RGLINT-00A	24" ADA Refrigerator, Panel Ready Glass Door	\$ 2,889	\$ 3,179
U-ADA24RGLS-13B	24" ADA Refrigerator, Stainless Glass Door, Locking	\$ 3,109	\$ 3,429
U-ADA24RINT-00A	24" ADA Refrigerator, Panel Ready Solid Door	\$ 2,709	\$ 2,989
U-ADA24RS-13B	24" ADA Refrigerator, Stainless Solid Door, Locking	\$ 2,909	\$ 3,209

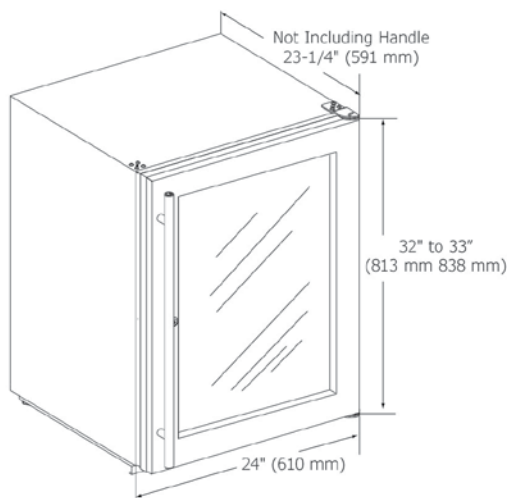

See Available Door Styles on Page 53. See Available Accessories on Page 61.

ADA 21" REFRIGERATOR/ICE MAKER



Features

- Refrigerator Volume of 2.1 Cu Ft Holds Up to 24 Bottles (12 oz) or 44 Cans (12 oz)
- Digital Touch Pad Control
- Temperature Range: 34°F to 45°F
- Produces and Stores Up to 8 Lb of Ice Per Day
- Crescent Ice Cube Dimensions: 1/2" W x 3/4" H x 2 1/4" L
- No Drain Required
- Two Removable Tempered Glass Shelves
- Field Reversible Door Is Shipped Right-Hand Hinged
- Built-In or Freestanding

Refrigerator/Ice Makers

MODEL	DESCRIPTION	MAP	MSRP
UARI121-BS01A	21" ADA Combo Frost Free Refrigerator, Black Solid Door	\$ 2,579	\$ 2,829
UARI121-SS01A	21" ADA Combo Frost Free Refrigerator, Stainless Solid Door	\$ 2,579	\$ 2,829
UARI121-WS01A	21" ADA Combo Frost Free Refrigerator, White Solid Door	\$ 2,579	\$ 2,829

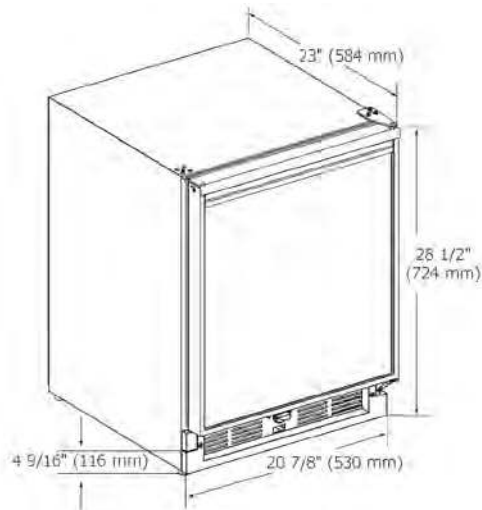

See Available Door Styles on Page 53. See Available Accessories on Page 61.

ADA ICE MAKERS



Features

- Dimensions: 14 7/8" W x 31 1/8" H x 23 5/8" D
- Produces Up to 39 Lb of Ice Per Day
- Stores 23 Lb of Ice
- Produces 3/4" Clear Ice Cubes
- Silent Setting Temporarily Suspends Ice Making for 3 Hours
- Digital Touch Pad Control
- Indicator Alert Notifies User When Cleaning Is Needed
- Black Interior
- Bright White LED Lighting
- Clear Heavy-Duty Ice Scoop Included
- Factory-Installed Drain Pump Included
- Stainless Steel Handle (7/8" Diameter)
- Field Reversible Door Is Shipped Right-Hand Hinged
- Built-In or Freestanding
- Four Adjustable Leveling Legs

ADA 15" Ice Maker

MODEL	DESCRIPTION	MAP	MSRP
UACP115-IS01A	15" ADA Clear Ice Machine, w/ Pump, Panel Ready Solid Door	\$ 3,659	\$ 4,039
UACP115-SS01A	15" ADA Clear Ice Machine, w/ Pump, Stainless Solid Door	\$ 3,909	\$ 4,299
UACR115-BS01A	15" ADA Crescent Ice Machine, Black Solid Door	\$ 2,939	\$ 3,229
UACR115-SS01A	15" ADA Crescent Ice Machine, Stainless Solid Door	\$ 2,939	\$ 3,229

ADA COMPACT ICE MAKERS



Features

- Dimensions: 14 13/16" W x 27 1/4" H x 20 3/32" D
- Makes Crescent-Shaped Cubes Approx. 1/2" W x 3/4" H x 2 1/4" L
- Produces Up to 39 Lbs of Ice Per Day
- Stores 25 Lbs of Ice
- On/Off Switch
- White Interior
- Stainless Steel Handle (7/8" Diameter)
- Field Reversible Door Is Shipped Right-Hand Hinged
- Built-In or Freestanding
- No Drain Required

ADA Compact Ice Makers

MODEL	DESCRIPTION	MAP	MSRP
UACR014-BS01A	14" ADA Crescent Ice Machine, Black Solid Door	\$ 1,569	\$ 1,729
UACR014-SS01A	14" ADA Crescent Ice Machine, Stainless Solid Door	\$ 2,109	\$ 2,319
UACR014-WS01A	14" ADA Crescent Ice Machine, White Solid Door	\$ 1,569	\$ 1,729
UACR015-BS01A	15" ADA Crescent Ice Machine, Black Solid Door	\$ 1,719	\$ 1,899
UACR015-SS01A	15" ADA Crescent Ice Machine, Stainless Solid Door	\$ 1,719	\$ 1,899
UACR015-WS01A	15" ADA Crescent Ice Machine, White Solid Door	\$ 1,719	\$ 1,899

See Available Door Styles on Page 53. See Available Accessories on Page 61.



Marine Collection

Durability and convenience for life at sea or on the road. Our collection of Marine ice makers and refrigerators are equipped with corrosive-resistant stainless steel hinges and fasteners, UV resistant cabinets and doors, and a secure travel latch. Maximum quality refrigeration and ice with practical details fit for use on land or water.

- 21" & 24" Refrigerators (4 models)
- Field reversible doors (including lock models).
- Bright white LED lighting on all models.
- 34° to 45° temperature ranges on all models – dairy safe.

Available Door Styles



Black Solid



Stainless Steel Solid



White Solid

* Not all door styles available for every application

MARINE REFRIGERATOR/ICE MAKER



Features

- Refrigerator Volume of 2.1 Cu Ft Holds Up to 24 Bottles (12 oz) or 44 Cans (12 oz)
- Mechanical Dial Control Conveniently Located on the Grille
- Temperature Range: ~34°F to 45°F
- Produces Up to 18 Lb of Ice Per Day
- Stores 13 Lb of Ice
- Crescent Ice Cube Dimensions: 1/2" W x 3/4" H x 2 1/4" L
- No Drain Required
- Two Removable Tempered Glass Shelves
- Two Fixed Storage Compartments in Door
- Standard Travel Package Includes Door Latch, Ensuring Safe-at-Sea Storage
- Corrosion and UV Resistant Components for Product Longevity in Harsh Environments
- Built-In or Freestanding

Refrigerator/Ice Maker

MODEL	DESCRIPTION	MAP	MSRP
UMRI121-BS01A	21" Marine Refrigerator w/ Ice, Black Solid Door	\$ 2,249	\$ 2,499
UMRI121-SS01A	21" Marine Refrigerator w/ Ice, Stainless Solid Door	\$ 2,249	\$ 2,499
UMRI121-WS01A	21" Marine Refrigerator w/ Ice, White Solid Door	\$ 2,249	\$ 2,499

See Available Door Styles on Page 58. See Available Accessories on Page 61.

MARINE ICE MAKERS



Features

- Makes Crescent-Shaped Cubes Approx. 1/2" W x 3/4" H x 2 1/4" L
- Produces Up to 23 Lb of Ice Per Day
- Stores 12 Lb of Ice
- On/Off Switch
- White Interior
- Stainless Steel Handle (7/8" Diameter)
- Field Reversible Door Is Shipped Right-Hand Hinged
- Built-In or Freestanding
- No Drain Required
- 230V Models Available.

Marine 14" Ice Maker

MODEL	DESCRIPTION	MAP	MSRP
UMCR014-BC01A	14" Marine Crescent Ice Machine, Flange to Cabinet, Black Solid Door	\$ 1,729	\$ 1,919
UMCR014-SC01A	14" Marine Crescent Ice Machine, Flange to Cabinet, Stainless Solid Door	\$ 2,219	\$ 2,449
UMCR014-SD01A	14" Marine Crescent Ice Machine, Flange to Door, Stainless Solid Door	\$ 2,219	\$ 2,449
UMCR014-SS01A	14" Marine Crescent Ice Machine, Stainless Solid Door	\$ 2,109	\$ 2,319
UMCR014-WC01A	14" Marine Crescent Ice Machine, Flange to Cabinet, White Solid Door	\$ 1,789	\$ 1,979



Marine 15" Ice Maker

MODEL	DESCRIPTION	MAP	MSRP
UMCR015-SS01A	15" Marine Crescent Ice Machine, Stainless Solid Door	\$ 2,079	\$ 2,289



Marine 14" Compact Ice Maker

MODEL	DESCRIPTION	MAP	MSRP
UMCR114-BC01A	14" Marine Crescent Ice Machine, Flange to Cabinet, Black Solid Door	\$ 1,909	\$ 2,099
UMCR114-SC01A	14" Marine Crescent Ice Machine, Flange to Cabinet, Stainless Solid Door	\$ 2,129	\$ 2,339
UMCR114-WC01A	14" Marine Crescent Ice Machine, Flange to Cabinet, White Solid Door	\$ 1,929	\$ 2,119

See Available Door Styles on Page 58. See Available Accessories on Page 61.

ACCESSORIES

Accessories

MODEL	DESCRIPTION	MAP	MSRP
ULAGRILLE15	15" Adjustable Black Grille, 3000 Series & 5 Class	\$ 109	\$ 119
ULAGRILLE18	18" Adjustable Black Grille, 3000 Series & 5 Class	\$ 129	\$ 149
ULAGRILLE24	24" Adjustable Black Grille, 3000 Series & 5 Class	\$ 149	\$ 169
ULASD18BIN	18" Slide & Divide Bin Organizer, 3000 Series & 5 Class	\$ 129	\$ 149
ULASD24DWR	24" Slide & Divide Drawer Organizer, 2000 Series & 3000 Series	\$ 129	\$ 149
ULASHP15FRAME	15" Stainless Glass Door, No Handle	\$ 399	\$ 439
ULASHP15SOLID	15" Stainless Solid Door, No Handle	\$ 349	\$ 389
ULASHP18FRAME	18" Stainless Glass Door, No Handle	\$ 449	\$ 499
ULASHP18SOLID	18" Stainless Solid Door, No Handle	\$ 399	\$ 439
ULASHP24DWR	24" Stainless Solid Drawers (2), No Handles	\$ 699	\$ 769
ULASHP24FRAME	24" Stainless Glass Door, No Handle	\$ 449	\$ 499
ULASHP24SOLID	24" Stainless Solid Door, No Handle	\$ 399	\$ 439

Dispenser Accessories

MODEL	DESCRIPTION	MAP	MSRP
ULATAPDOUBLE	Double Tapper Kit	\$ 1,299	\$ 1,429
ULATAPSINGLE	Single Tapper Kit	\$ 999	\$ 1,099

Ice Machine Accessories

MODEL	DESCRIPTION	MAP	MSRP
ULADRAINPUMP115V	Ice Machine Drain Pump	\$ 1,299	\$ 1,429
80-55667-00	4 oz. Clear Ice Machine Cleaner	\$ 59	\$ 69
ULAFREESTANDB	24" Free Standing Kit, Black	\$ 169	\$ 189
ULAFREESTANDS	24" Free Standing Kit, Stainless	\$ 199	\$ 219
ULAWATERHOOKUP	Water Line Hook Up Kit	\$ 199	\$ 219
ULA15SPNUGGETSOLID	15" Stainless Solid Door for URNP115-IS01A Nugget Ice Machine	\$ 229	\$ 259



130 Years of Crafted Excellence

When you choose Marvel Premium Refrigeration, you're choosing 130 years of quality and leading innovation in the luxury refrigeration business. You're choosing carefully designed products and most importantly, you're choosing the best undercounter refrigeration technology available on the market.

As the longest-standing refrigeration company in North America, we are proud to have pioneered numerous advancements that helped shape refrigeration technology into what it is today.

Our decorated past began in 1892 in Greenville, Michigan, a beautiful, tightly-knit community where our manufacturing facility is still based today. Here, we created the first foamed-in-place refrigerator, and the first refrigeration of its kind with sleek stainless steel interiors and glass doors. We were also first to adopt a midnight black interior for wine cellars and beverage centers, now a very popular and practical aesthetic.

Our legacy of quality craftsmanship continues to stand strong throughout the centuries, driving the performance the industry has come to expect from Marvel. The extensive Marvel product offering is world class, a dynamic selection of sophisticated, high-performance wine cellars, beverage centers, indoor and outdoor refrigerators, ice machines and beer dispensers.







WHY MARVEL?

VERSATILE, ADAPTABLE DESIGN

Adjusts to your lifestyle and storage habits

The benchmark for clever design and storage flexibility, Marvel offers a multitude of size options, finishes and shelving configurations for home and outdoor. We maximized our interior volume and added adjustable shelving to quickly adapt the configuration to your particular storage needs. Our 3-in-1 Convertible Shelving gives you up to three storage options within one shelf and our MaxStore Bins offer high capacity, clear-view storage on smooth ball-bearing glides.

COOLING PERFORMANCE

Precise, consistent cooling and rapid cool down

Our distinctive design features a thermal-efficient cabinet and door combined with Dynamic Cooling Technology for superior temperature stability, faster cooling times and speedy temperature recovery. Dynamic Cooling simply means these products contain an exclusive, high efficiency fan that facilitates heat transfer by circulating cold storage compartment air over the evaporator and contents.

SUSTAINABILITY

Designed to protect your contents (and utility bills)

With a wide range of products that meet ENERGY STAR® requirements, Marvel stands above the rest. We thoughtfully design our products to be as energy efficient as possible, without sacrificing cooling power or the features you desire most. By using environmentally friendly R600a refrigerant, and recycling over 1 million pounds of material each year, we are committed to creating a better environment for generations to come.

FIT & FINISH

Quality is measured in the details

Marvel products are designed to blend seamlessly into any design. Whether you love the look of our robust professional products or prefer the sleek design of our classic line, our wide range of appliances offers an aesthetic for everyone. Many of our products are available not only in timeless stainless steel, but also offer a panel-ready finish designed to accept a custom overlay frame or solid panel to match your surrounding cabinetry and hardware. The finishes and finishing touches of our carefully designed products bring a truly luxurious feel to any space.

DESIGNED & BUILT IN AMERICA

The original refrigeration experts since 1892

Marvel products are engineered, built, and inspected against stringent quality standards in the our manufacturing facility based in Greenville, Michigan. We are committed to building a quality product in an environmentally-friendly manner through tightly controlled and closely monitored processes. When you choose Marvel Premium Refrigeration, you're choosing 130 years of handcrafted quality and leading innovation.





Classic Collection



- Largest Collection With Broad Range of Complementary Products at Competitive Price Points
- 24" & 15" Size Options
- Field Reversible Doors (Excluding Models With Door Storage)
- Arctic White LED Interior Lighting (BrightShield Antimicrobial Lighting on Select Refrigerators & Ice Machines)
- Pivot Hinges
- Half-Width Shelves on Select Beverage Centers & Refrigerators to Accommodate Tall Items
- Black and Maple Wood Shelf Accents
- Adjustable Cantilevered Shelving With 3-in-1 Convertible Shelving to Store a Combination of Food, Beverages, & Wine
- Tube Style Door Handle
- 1 Year Warranty (Parts & Labor) / 5 Year Sealed System Warranty (Parts)

Professional Collection



- Premium Product Line With Industry-Leading Features & Craftsmanship
- Dynamic Cooling Technology for Superior Temperature Stability, Faster Cooldown Times and Speedy Temperature Recovery
- 24" & 15" Size Options
- Field Reversible Doors (Excluding Drawers)
- Arctic White & Sapphire Blue LED Interior Lighting (BrightShield Antimicrobial Lighting on Select Refrigerators & Ice Machines)
- Concealed Soft-Close Articulating Door Hinges
- Half-Width Shelves on Select Beverage Centers & Refrigerators to Accommodate Tall Items
- Stainless Steel Shelf Accents
- Adjustable Cantilevered Shelving With 3-in-1 Convertible Shelving to Store a Combination of Food, Beverages, & Wine
- Robust, Professional Style Door Handle
- Door Lock Standard (Excluding Ice Machines)
- 2 Year Warranty (Parts & Labor) / 5 Year Sealed System Warranty (Parts). Additional 1 Year Warranty Available With Registration

COLLECTION COMPARISON

CLASSIC

VS

PROFESSIONAL

PIVOT HINGE



ARTICULATING HINGE

BLACK AND WOOD ACCENTS



STAINLESS STEEL ACCENTS

CANTILEVER METAL SHELVING



CANTILEVER METAL SHELVING WITH GLIDE-OUT CONVERTIBLE 3-IN-1 SHELVES

TUBE STYLE DOOR HANDLE



PROFESSIONAL STYLE DOOR HANDLE

ARCTIC WHITE LED LIGHTING WITH BRIGHTSHIELD ON SELECT MODELS



ARCTIC WHITE AND SAPPHIRE BLUE, BRIGHTSHIELD ON SELECT MODELS

DOOR LOCK NOT INCLUDED



DOOR LOCK STANDARD (EXCEPT ICE)

1-YEAR PARTS & LABOR WARRANTY,
5-YEAR SEALED SYSTEM PARTS WARRANTY



3-YEAR PARTS & LABOR WARRANTY WITH PRODUCT REGISTRATION, 5-YEAR SEALED SYSTEM PARTS WARRANTY



Professional Collection

At Marvel, we pride ourselves in the craftsmanship of our products, evident in each distinct detail. From the fully extendable, smooth ball-bearing roller glides to the sturdy stainless steel accents, our Professional Collection of products preserve food, beverages and wine as they were intended and produce premium ice cubes ideal for any beverage, elevating your kitchen and enhancing your culinary experience.

- Premium Product Line With Industry-Leading Features & Craftsmanship
- Available in 24" & 15" Size Options
- Field Reversible Doors (Excluding Drawers)
- Arctic White & Sapphire Blue LED Interior Lighting (BrightShield™ Antimicrobial Lighting on Select Refrigerators & Ice Machines)
- Concealed Soft-Close Articulating Door Hinges
- Half-Width Shelves on Select Beverage Centers & Refrigerators to Accommodate Tall Items
- Stainless Steel Shelf Accents
- Adjustable Cantilevered Shelving With 3-in-1 Convertible Shelving to Store Food, Beverages, & Wine
- Robust, Professional Style Door Handle
- Standard Door Lock (Excluding Ice Machines)
- 2-Year Parts & Labor / 5-Year Sealed System Parts Warranty, With Additional 1-Year Warranty Available Upon Registration

Available Door Styles



Panel Ready Drawers

Stainless Steel Drawers

Panel Ready Glass

Panel Ready Solid

Stainless Steel Glass

Stainless Steel Solid

* Not all door styles available for every application.

PROFESSIONAL COLLECTION REFRIGERATORS



Features

- Models With BrightShield™ Antimicrobial Lighting Create a More Hygienic Environment for Foods and Beverages
- Available in 24-In Professional Built-In Refrigerated Drawers or Refrigerator Models With Capacities of 5.2 to 5.5 Cu. Ft., Storing Up to 108 Cans (12 oz) or 7 Wine Bottles and 162 Cans
- Adjustable Divider in Drawers or 3-in-1 Convertible Shelves With Wine Rack Option for Tall and Loose Item Storage
- Dynamic Cooling Technology Provides Temperature Stability
- Digital Controls Allow Temperature Selection From 33°F to 70°F, With Door Ajar and High/Low Temperature Alerts
- Adjustable LED Theater-Style Lighting in Arctic White or Sapphire Blue; Some Models Feature BrightShield™ Antimicrobial Lighting for a Hygienic Environment
- Elegant Midnight Black Interior with Robust Full-Length Handle and Stainless Steel Accents
- Drawer Models Include Stainless Steel Interior
- Reversible, Soft-Close Door or Soft-Close Glides With Concealed Articulating Door Hinges
- Argon-Filled, UV-Resistant Tinted Dual Pane Glass Door on Select Models
- Door Lock for Added Security

Refrigerators

MODEL	DESCRIPTION	UMRP	MSRP
MPRE424-IG81A	24" Professional Refrigerator, Panel Ready Glass Door, BrightShield	\$ 3,699	\$ 4,079
MPRE424-IS81A	24" Professional Refrigerator, Panel Ready Solid Door, BrightShield	\$ 3,569	\$ 3,929
MPRE424-SG81A	24" Professional Refrigerator, Stainless Glass Door, BrightShield	\$ 3,779	\$ 4,159
MPRE424-SS81A	24" Professional Refrigerator, Stainless Solid Door, BrightShield	\$ 3,629	\$ 3,999
MPRE424-IG31A	24" Professional Refrigerator, Panel Ready Glass Door, Locking	\$ 3,489	\$ 3,839
MPRE424-IS31A	24" Professional Refrigerator, Panel Ready Solid Door, Locking	\$ 3,349	\$ 3,689
MPRE424-SG31A	24" Professional Refrigerator, Stainless Glass Door, Locking	\$ 3,569	\$ 3,929
MPRE424-SS31A	24" Professional Refrigerator, Stainless Solid Door, Locking	\$ 3,419	\$ 3,749
MPDR424-IS71A	24" Professional Refrigerator Drawers, Panel Ready Solid Drawers, Locking	\$ 4,519	\$ 4,979
MPDR424-SS71A	24" Professional Refrigerator Drawers, Stainless Solid Drawers, Locking	\$ 4,599	\$ 5,069

See Available Door Styles on Page 68. See Available Accessories on Page 76.

PROFESSIONAL COLLECTION BEVERAGE CENTERS



Features

- 15": 2.7 Cu. Ft. Capacity Stores Up to 35 Cans (12 oz) or 6 Wine Bottles
- 24": 5.5 Cu. Ft. Capacity Stores Up to 19 Wine Bottles (14 Flat, 5 Cradled) and Holds Up to 108 Cans (12 oz)
- Display Wine Rack Glides Out for Easy Access and Holds Up to 5 Wine Bottles, Including Magnum Sizes
- (2) 3-in-1 Glide-Out Convertible Shelves Feature Removable Glass Pane with Wine Rack Option to Store Beverages, Food, or Wine
- Cantilevered Shelving System Can Hold Up to 35 Lbs and Features 11 Adjustable Heights
- Digital Controls Allow You to Select a Temperature from 33°F to 70°F
- Dynamic Cooling Technology Delivers Temperature Stability
- Adjustable LED Theater-Style Lighting in Arctic White or Sapphire Blue
- Door Ajar and High/Low Temperature Alerts
- Argon-Filled, UV-Resistant Tinted Dual Pane Glass Door Protects Contents
- Professional Styling: Robust Full-Length Handle and Stainless Steel Accents
- Elegant Midnight Black Interior
- Door Lock Provides Added Security
- Reversible Door Allows for Right or Left Swing
- Concealed Soft-Close Articulating Door Hinge

Beverage Centers

MODEL	DESCRIPTION	UMRP	MSRP
MPBV415-IG31A	15" Professional Beverage Center, Panel Ready Glass Door, Locking	\$ 2,879	\$ 3,169
MPBV415-IS31A	15" Professional Beverage Center, Panel Ready Solid Door, Locking	\$ 2,739	\$ 3,019
MPBV415-SG31A	15" Professional Beverage Center, Stainless Glass Door, Locking	\$ 2,959	\$ 3,249
MPBV415-SS31A	15" Professional Beverage Center, Stainless Solid Door, Locking	\$ 2,809	\$ 3,099
MPBV424-IG31A	24" Professional Beverage Center, Panel Ready Glass Door, Locking	\$ 3,319	\$ 3,669
MPBV424-IS31A	24" Professional Beverage Center, Panel Ready Solid Door, Locking	\$ 3,189	\$ 3,509
MPBV424-SG31A	24" Professional Beverage Center, Stainless Glass Door, Locking	\$ 3,399	\$ 3,729
MPBV424-SS31A	24" Professional Beverage Center, Stainless Solid Door, Locking	\$ 3,249	\$ 3,589

See Available Door Styles on Page 68. See Available Accessories on Page 76.

PROFESSIONAL COLLECTION DUAL ZONE BEVERAGE CENTERS



Features

- 5.5 Cu. Ft. Capacity Stores Up to 19 Wine Bottles (14 Flat, 5 Cradled) and Holds Up to 108 Cans (12 oz)
- Display Wine Rack Glides Out for Easy Access and Holds Up to 5 Wine Bottles, Including Magnum Sizes
- (2) 3-in-1 Glide-Out Convertible Shelves Feature Removable Glass Pane with Wine Rack Option to Store Beverages, Food, or Wine
- Cantilevered Shelving System Can Hold Up to 35 Lbs and Features 11 Adjustable Heights
- Digital Controls Allow You to Select a Temperature from 33°F to 70°F
- Dynamic Cooling Technology Delivers Temperature Stability
- Adjustable LED Theater-Style Lighting in Arctic White or Sapphire Blue
- Door Ajar and High/Low Temperature Alerts
- Argon-Filled, UV-Resistant Tinted Dual Pane Glass Door Protects Contents
- Professional Styling: Robust Full-Length Handle and Stainless Steel Accents
- Elegant Midnight Black Interior
- Door Lock Provides Added Security
- Reversible Door Allows for Right or Left Swing
- Concealed Soft-Close Articulating Door Hinge

Beverage Centers

MODEL	DESCRIPTION	UMRP	MSRP
MPBD424-IG31A	24" Professional Dual Zone Beverage Center, Panel Ready Glass Door, Locking	\$ 4,449	\$ 4,889
MPBD424-IS31A	24" Professional Dual Zone Beverage Center, Panel Ready Solid Door, Locking	\$ 4,299	\$ 4,739
MPBD424-SG31A	24" Professional Dual Zone Beverage Center, Stainless Glass Door, Locking	\$ 4,509	\$ 4,969
MPBD424-SS31A	24" Professional Dual Zone Beverage Center, Stainless Solid Door, Locking	\$ 4,369	\$ 4,809

See Available Door Styles on Page 68. See Available Accessories on Page 76.

PROFESSIONAL COLLECTION WINE REFRIGERATORS



Features

- 24": 5.2 Cu. Ft. Capacity Stores 48 Bottles of Wine
- 15": 2.7 Cu. Ft. Capacity Stores Up to 24 Bottles of Wine
- Includes (5) 8-Bottle Wine Racks and (2) 4-Bottle Half-Depth Wine Racks
- Vibration Neutralization System Protects Wine from Agitation
- Dynamic Cooling Technology Delivers Temperature Stability
- Argon-Filled, UV-Resistant Tinted Dual Pane Glass Door Protects Contents
- Digital Controls Allow You to Select a Temperature from 33°F to 70°F
- Door Ajar and High/Low Temperature Alerts
- Adjustable LED Theater-Style Lighting in Arctic White or Sapphire Blue
- Elegant Midnight Black Interior
- Professional Styling: Robust Full-Length Handle and Stainless Steel Accents
- Reversible Door Allows for Right or Left Swing
- Door Lock Provides Added Security
- Concealed Soft-Close Articulating Door Hinge

Single Zone Wine Refrigerators

MODEL	DESCRIPTION	UMRP	MSRP
MPWC415-IG31A	15" Professional Wine Refrigerator, Panel Ready Glass Door, Locking	\$ 3,019	\$ 3,319
MPWC415-IS31A	15" Professional Wine Refrigerator, Panel Ready Solid Door, Locking	\$ 2,879	\$ 3,169
MPWC415-SG31A	15" Professional Wine Refrigerator, Stainless Glass Door, Locking	\$ 3,089	\$ 3,409
MPWC415-SS31A	15" Professional Wine Refrigerator, Stainless Solid Door, Locking	\$ 2,959	\$ 3,249
MPWC424-IG31A	24" Professional Wine Refrigerator, Panel Ready Glass Door, Locking	\$ 3,319	\$ 3,669
MPWC424-IS31A	24" Professional Wine Refrigerator, Panel Ready Solid Door, Locking	\$ 3,189	\$ 3,509
MPWC424-SG31A	24" Professional Wine Refrigerator, Stainless Glass Door, Locking	\$ 3,399	\$ 3,729
MPWC424-SS31A	24" Professional Wine Refrigerator, Stainless Solid Door, Locking	\$ 3,249	\$ 3,589

See Available Door Styles on Page 68. See Available Accessories on Page 76.

STOCK ITEMS ARE LISTED IN RED

PROFESSIONAL COLLECTION DUAL ZONE WINE REFRIGERATORS



Features

- 4.9 Cu. Ft. Capacity, Upper Zone Includes Three 8-Bottle Wine Racks, Lower Zone Includes One 8-Bottle Wine Rack and Two 4-Bottle Half-Depth Wine Racks
- Upper Zone: Includes Three 8-Bottle Wine Racks
- Lower Zone: Includes One 8-Bottle Wine Rack and Two 4-Bottle Half-Depth Wine Racks
- Dynamic Cooling Technology Provides Temperature Stability With Vibration Neutralization System to Protect Wine From Agitation
- Argon-Filled, UV-Resistant Tinted Dual Pane Glass Door Protects Contents
- Digital Controls Offers Separate Temperature Control (Upper Zone: 38°F to 65°F, Lower Zone: 38°F to 65°F)
- Door Ajar and High/Low Temperature Alerts, With Adjustable LED Theater-Style Lighting in Arctic White or Sapphire Blue
- Elegant Midnight Black Interior With Professional Styling, Robust Full-Length Handle, and Stainless Steel Accents
- Reversible Door for Right or Left Swing With Concealed Soft-Close Articulating Door Hinge
- Door Lock for Added Security

Dual Zone Wine Refrigerators

MODEL	DESCRIPTION	UMRP	MSRP
MPWD424-IG31A	24" Professional Dual Zone Wine Refrigerator, Panel Ready Glass Door, Locking	\$ 4,449	\$ 4,889
MPWD424-IS31A	24" Professional Dual Zone Wine Refrigerator, Panel Ready Solid Door, Locking	\$ 4,299	\$ 4,739
MPWD424-SG31A	24" Professional Dual Zone Wine Refrigerator, Stainless Glass Door, Locking	\$ 4,509	\$ 4,969
MPWD424-SS31A	24" Professional Dual Zone Wine Refrigerator, Stainless Solid Door, Locking	\$ 4,369	\$ 4,809

See Available Door Styles on Page 68. See Available Accessories on Page 76.

PROFESSIONAL COLLECTION REFRIGERATOR/FREEZER



Features

- 4.9 Cu. Ft. Capacity Stores Up to 72 Cans (12 oz)
- 1 Cu. Ft. Freezer Stores Up to 12 Pints of Ice Cream or Crescent Ice Maker Produces Up to 7 Lbs of Ice Daily and Stores Up to 13 Lbs of Ice
- 2 Half-Width Cantilevered Shelves and 1 Full-Width Fixed Shelf
- Dynamic Cooling Technology Delivers Temperature Stability
- Digital Controls Allow You to Select a Refrigerator Temperature of 34°F to 42°F
- Door Ajar and High/Low Temperature Alerts
- Adjustable LED Theater-Style Lighting in Arctic White or Sapphire Blue
- Elegant Midnight Black Interior
- Professional Styling: Robust Full-Length Handle and Stainless Steel Accents
- Reversible Door Allows for Right or Left Swing
- Door Lock Provides Added Security
- Concealed Soft-Close Articulating Door Hinge

Refrigerator/Freezer

MODEL	DESCRIPTION	UMRP	MSRP
MPRF424-IS31A	24" Professional Refrigerator/Freezer, Panel Ready Solid Door, Locking	\$ 3,419	\$ 3,749
MPRF424-SS31A	24" Professional Refrigerator/Freezer, Stainless Solid Door, Locking	\$ 3,569	\$ 3,929

Refrigerator/Freezer with Ice

MODEL	DESCRIPTION	UMRP	MSRP
MPRI424-IS31A	24" Professional Refrigerator/Freezer, w/ Ice, Panel Ready Solid Door, Locking	\$ 3,569	\$ 3,929
MPRI424-SS31A	24" Professional Refrigerator/Freezer, w/ Ice, Stainless Solid Door, Locking	\$ 3,679	\$ 4,059

See Available Door Styles on Page 68. See Available Accessories on Page 76.

STOCK ITEMS ARE LISTED IN RED

PROFESSIONAL COLLECTION FREEZER



Features

- 4.6 Cu. Ft. Capacity
- 3 Chrome Wire Bins
- Dynamic Cooling Technology Delivers Temperature Stability
- Digital Controls Allow You to Select a Temperature from -10°F to 10°F
- Door Ajar and High/Low Temperature Alerts
- Adjustable LED Theater-Style Lighting in Arctic White or Sapphire Blue
- Elegant Midnight Black Interior
- Professional Styling: Robust Full-Length Handle and Stainless Steel Accents
- Reversible Door Allows for Right or Left Swing
- Door Lock Provides Added Security
- Concealed Soft-Close Articulating Door Hinge

Freezer

MODEL	DESCRIPTION	UMRP	MSRP
MPFZ424-IS31A	24" Professional Freezer, Panel Ready Solid Door, Locking	\$ 3,869	\$ 4,269
MPFZ424-SS31A	24" Professional Freezer, Stainless Solid Door, Locking	\$ 4,089	\$ 4,509

See Available Door Styles on Page 68. See Available Accessories on Page 76.



STOCK ITEMS ARE LISTED IN RED

MARVEL REFRIGERATION ACCESSORIES

Installation Accessories

MODEL	DESCRIPTION	UMRP	MSRP
42242832-ACCY	18" Black Filler Kit	\$ 79	\$ 89
42242833-ACCY	18" Stainless Filler Kit	\$ 79	\$ 89
42249443-ACCY	Stacking Kit (24" Models)	\$ 129	\$ 149

Shelving Accessories

MODEL	DESCRIPTION	UMRP	MSRP
42248725-ACCY	24" Half-Width Flat Shelf, Natural Maple Front	\$ 29	\$ 39
42248729-ACCY	24" Full-Width Flat Shelf, Natural Maple Front	\$ 29	\$ 39



Ice Makers

Marvel Ice Machines allow you to enjoy ice cold drinks anywhere in your home, from your kitchen or wet bar to your home gym and beyond. Choose from three types of ice making appliances – clear ice machines that make practically perfect clear ice cubes that preserve the integrity of your fine spirits, nugget ice machines that make the ever-popular ice bits, and crescent ice makers that do not require a drain.

- Largest Collection With Broad Range of Complementary Products at Competitive Price Points
- 15" and Compact Size Options
- Field Reversible Doors (Excluding Models With Door Storage)
- Arctic White LED Interior Lighting (BrightShield Antimicrobial Lighting on Select Ice Machines)
- Pivot Hinges or Soft Closing Articulating Hinges
- Tube Style Door Handle
- 1 Year Warranty (Parts & Labor) / 5 Year Sealed System Warranty (Parts)

Available Door Styles



Panel Ready
Solid



Stainless Steel
Glass



Stainless Steel
Solid

* Not all door styles available for every application.

PROFESSIONAL COLLECTION CLEAR ICE MACHINES



Features

- BrightShield™ Antimicrobial Lighting Creates a More Hygienic Environment for Ice
- Produces 3/4 Inch Clear Ice Cubes, Up to 39 Lbs of Ice Per Day
- Stores Up to 28 Lbs of Ice
- Ice Scoop Included With Dedicated Holder
- Factory-Installed Drain Pump Included
- Digital Controls Feature Audible Alerts and Programmed Cleaning Reminders
- Adjustable LED Theater Style Lighting in Arctic White or Sapphire Blue (Non-BrightShield Models)
- Elegant Midnight Black Interior
- Professional Styling: Robust Full-Length Handle and Stainless Steel Accents
- Reversible Door Allows for Right or Left Swing
- Concealed Soft Close Articulating Door Hinge
- Temporarily Suspend Ice Making for 3 Hours With Silent Mode

Available Ice Styles

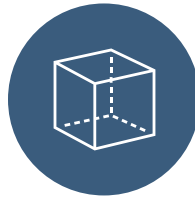

Ice Machines

MODEL	DESCRIPTION	UMRP	MSRP
MPCP415-IS81A	15" Professional Clear Ice Machine, w/ Pump, Panel Ready Solid Door, BrightShield	\$ 3,499	\$ 3,849
MPCP415-SS81A	15" Professional Clear Ice Machine, w/ Pump, Stainless Solid Door, BrightShield	\$ 3,499	\$ 3,849
MPCP415-SG81A	15" Professional Clear Ice Machine, w/ Pump, Stainless Glass Door, BrightShield	\$ 4,939	\$ 5,439
MPCP415-IS01A	15" Professional Clear Ice Machine, w/ Pump, Panel Ready Solid Door	\$ 4,059	\$ 4,469
MPCP415-SS01A	15" Professional Clear Ice Machine, w/ Pump, Stainless Solid Door	\$ 4,109	\$ 4,529
MPCP415-SG01A	15" Professional Clear Ice Machine, w/ Pump, Stainless Glass Door	\$ 4,719	\$ 5,199

See Available Door Styles on Page 77. See Available Accessories on Page 83.

STOCK ITEMS ARE LISTED IN RED

CLASSIC COLLECTION ICE MACHINES



Nugget Ice (MRNP215-IS01A)

Features

- Clear Ice (3/4" Cube) Produces Up to 39 Lbs per Day With a Storage Capacity of Up to 28 Lbs
- Nugget Ice (1/2" L x 3/8" H x 5/8" W) Produces Up to 65 Lbs per Day With a Storage Capacity of Up to 27 Lbs
- Crescent Ice (1/2" W x 3/4" H x 2-1/4" L) Produces Up to 25 Lbs per Day With a Storage Capacity of Up to 25 Lbs
- BrightShield™ Antimicrobial Lighting on Select Models for a Hygienic Ice Environment
- Includes Ice Scoop With Dedicated Holder and Factory-Installed Drain Pump (Select Models)
- Digital Controls With Audible Alerts, Cleaning Reminders, and Sabbath Mode; Some Models Offer Simple Clean Cycles and Indicator Lights for Drain and Water Issues
- Arctic White LED Lighting and Elegant Midnight Black or Arctic White Interior
- Reversible Door for Right or Left Swing, Panel-Ready Options on Select Models
- Silent Mode to Temporarily Suspend Ice Making for 3 Hours on Select Models

Available Ice Styles

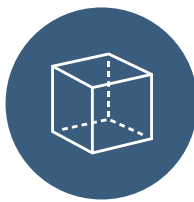

Clear



Nugget

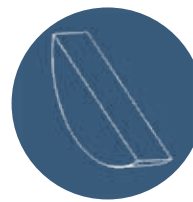

Crescent

Ice Machines

MODEL	DESCRIPTION	UMRP	MSRP
MLCP215-IS81A	15" Classic Clear Ice Machine, w/ Pump, Panel Ready Solid Door, BrightShield	\$ 2,499	\$ 2,749
MLCP215-SS81A	15" Classic Clear Ice Machine, w/ Pump, Stainless Solid Door, BrightShield	\$ 2,499	\$ 2,749
MLCL215-IS01B	15" Classic Clear Ice Machine, Panel Ready Solid Door	\$ 3,209	\$ 3,529
MLCL215-SG01B	15" Classic Clear Ice Machine Stainless Glass Door	\$ 3,819	\$ 4,209
MLCL215-SS01B	15" Classic Clear Ice Machine Stainless Solid Door	\$ 3,349	\$ 3,689
MLCP215-IS01B	15" Classic Clear Ice Machine, w/ Pump, Panel Ready Solid Door	\$ 3,669	\$ 4,049
MLCP215-SG01B	15" Classic Clear Ice Machine, w/ Pump, Stainless Glass Door	\$ 4,229	\$ 4,659
MLCP215-SS01B	15" Classic Clear Ice Machine, w/ Pump, Stainless Solid Door	\$ 3,819	\$ 4,209
MRNP215-IS01A	15" Classic Nugget Ice Machine, w/ Pump, Panel Ready Solid Door	\$ 4,599	\$ 5,059
MRNP215-SS01A	15" Classic Nugget Ice Machine, w/ Pump, Stainless Solid Door	\$ 4,759	\$ 5,239
MLCR215-IS01B	15" Classic Crescent Ice Machine, Panel Ready Solid Door	\$ 2,399	\$ 2,639
MLCR215-SS01B	15" Classic Crescent Ice Machine, Stainless Solid Door	\$ 2,579	\$ 2,839

See Available Door Styles on Page 77. See Available Accessories on Page 83.

OUTDOOR COLLECTION ICE MACHINES

Features

- 15-In Outdoor Built-In Clear Ice Machine: Produces 3/4 Inch Clear Ice Cubes, Up to 39 Lbs of Ice Daily, and Stores Up to 28 Lbs; Includes Factory-Installed Drain Pump on Select Models
- 15-In Outdoor Nugget Ice Machine: Produces 1/2" L x 3/8" H x 5/8" W Nugget Ice Bits, Up to 65 Lbs of Ice Daily, and Stores Up to 27 Lbs; Includes Factory-Installed Drain Pump and Simple 20-Minute Clean Cycle
- 15-In Outdoor Built-In Crescent Ice Machine: Produces and Stores Up to 25 Lbs of Crescent Ice Daily (1/2" W x 3/4" H x 2-1/4" L); Removable Ice Bin; No Pump or Drain Required
- Digital Controls Feature Audible Alerts, Cleaning Reminders, and Sabbath Mode; Select Models Include Indicator Lights for Drain and Water Issues
- Includes Ice Scoop With Dedicated Holder
- Arctic White LED Light; Arctic White Interior on Nugget and Crescent Ice Models
- Reversible Door Allows for Right or Left Swing; Soft-Close on Nugget Model
- Temporarily Suspend Ice Making for 3 Hours With Silent Mode (Clear Ice Models)

Available Ice Styles

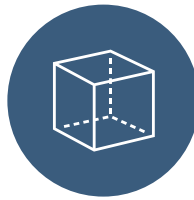

Clear

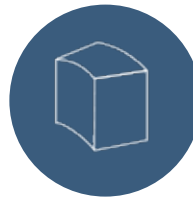

Nugget

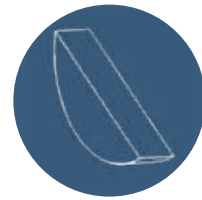

Crescent



Ice Machines

MODEL	DESCRIPTION	UMRP	MSRP
MOCL215-SS01B	15" Outdoor Clear Ice Machine, Stainless Solid Door	\$ 4,039	\$ 4,449
MOCP215-SS01B	15" Outdoor Clear Ice Machine, w/ Pump, Stainless Solid Door	\$ 4,489	\$ 4,939
MOCR215-SS01B	15" Outdoor Crescent Ice Machine, Stainless Solid Door	\$ 3,159	\$ 3,479
MONP215-SS01A	15" Outdoor Nugget Ice Machine, w/ Pump, Stainless Solid Door	\$ 4,899	\$ 5,389

See Available Door Styles on Page 77. See Available Accessories on Page 83.

STOCK ITEMS ARE LISTED IN RED

LOW PROFILE COLLECTION COMPACT ICE MACHINES



Features

- Produces Up to 39 Lbs of Ice Per Day
- Stores Up to 12 Lbs of Crescent Ice
- Removable Ice Bin
- No Pump or Drain Required
- Crescent Ice Dimensions: 1/2 Inch W x 3/4 Inch H x 2-1/4 Inch L
- On / Off Switch
- Arctic White Interior
- Reversible Door Allows for Right or Left Swing

Available Ice Styles

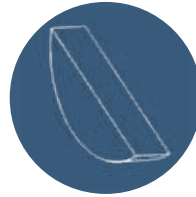

Crescent

Compact Ice Machines

MODEL	DESCRIPTION	UMRP	MSRP
MACR214-BS01B	14" Low Profile Crescent Ice Machine, Black Solid Door	\$ 1,599	\$ 1,759
MACR214-SS01B	14" Low Profile Crescent Ice Machine, Stainless Solid Door	\$ 1,599	\$ 1,759

Available Door Styles



LOW PROFILE COLLECTION ICE MACHINES



Features

- Clear Ice Produces 3/4 Inch Clear Ice Cubes, Up to 39 Lbs of Clear Ice Daily, Stores Up to 28 Lbs of Ice
- Crescent Ice Produces: 1/2 Inch x 3/4 Inch x 2-1/4 Inch Cubes, Produces and Stores Up to 25 Lbs of Ice Per Day
- Digital Controls Feature Audible Alerts and Programmed Cleaning Reminders
- Audible Alerts, Cleaning Reminders, and Sabbath Mode
- Arctic White LED Light
- Elegant Midnight Black Interior (Clear Ice)
- Arctic White Interior(Crescent Ice)
- Reversible Door Allows for Right or Left Swing
- Temporarily Suspend Ice Making for 3 Hours With Silent Mode

Available Ice Styles

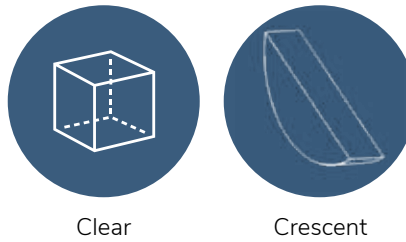

Ice Machines

MODEL	DESCRIPTION	UMRP	MSRP
MACL215-IS01B	15" Low Profile Clear Ice Machine, Panel Ready Solid Door	\$ 3,189	\$ 3,509
MACL215-SS01B	15" Low Profile Clear Ice Machine, Stainless Solid Door	\$ 3,449	\$ 3,799
MACP215-IS01B	15" Low Profile Clear Ice Machine, w/ Pump, Panel Ready Solid Door	\$ 3,659	\$ 4,039
MACP215-SS01B	15" Low Profile Clear Ice Machine, w/ Pump, Stainless Solid Door	\$ 3,909	\$ 4,299
MACR215-SS01B	15" Low Profile Crescent Ice Machine, Stainless Solid Door	\$ 2,939	\$ 3,229

See Available Door Styles on Page 77. See Available Accessories on Page 83.



STOCK ITEMS ARE LISTED IN RED

MARVEL REFRIGERATION ACCESSORIES

Ice Maker Accessories

MODEL	DESCRIPTION	UMRP	MSRP
S41013789	4 oz. Ice Machine Cleaner	\$ 59	\$ 69
90-17047-ACCY	Stainless Solid Door w/ Pro-Style Handle for MRNP215-IS01A Nugget Ice Machine	\$ 229	\$ 259

Installation Accessories

MODEL	DESCRIPTION	UMRP	MSRP
42242832-ACCY	18" Black Filler Kit	\$ 79	\$ 89
42242833-ACCY	18" Stainless Filler Kit	\$ 79	\$ 89
42249443-ACCY	Stacking Kit (24" Models)	\$ 129	\$ 149



Classic Collection

Classic by design. Our broad Classic Collection of products are known for their optimal style and leading innovation. Continuing to uphold the standards of quality and signature features for generations, these popular refrigeration products continue to drive our reputation and status in the undercounter appliance industry.

- Largest Collection With Broad Range of Complementary Products at Competitive Price Points
- 24" & 15" Size Options
- Field Reversible Doors (Excluding Models With Door Storage)
- Arctic White LED Interior Lighting (BrightShield Antimicrobial Lighting on Select Refrigerators & Ice Machines)
- Pivot Hinges
- Half-Width Shelves on Select Beverage Centers & Refrigerators to Accommodate Tall Items
- Black and Maple Wood Shelf Accents
- Adjustable Cantilevered Shelving With 3-in-1 Convertible Shelving to Store a Combination of Food, Beverages, & Wine
- Tube Style Door Handle
- 1 Year Warranty (Parts & Labor) / 5 Year Sealed System Warranty (Parts)

Available Door Styles



Panel Ready Drawers



Stainless Steel Drawers



Panel Ready Glass



Panel Ready Solid



Stainless Steel Glass



Stainless Steel Solid



Black Glass

* Not all door styles available for every application.

STOCK ITEMS ARE LISTED IN RED

CLASSIC COLLECTION REFRIGERATORS



MLRE124



Features

- 5.1 Cu. Ft. Capacity Stores 115 Cans (12 oz)
- MaxStore Bin Stores Loose Items (not available on MLRE024 model)
- Built-In Door Storage System (excludes MLRE024)
- Half-Width Shelf Allows for Tall Item Storage
- Includes 1 Cantilevered Black Steel-Framed Glass Shelf and 1 Fixed Steel-Framed Glass Shelf
- Dynamic Cooling Technology Delivers Temperature Stability
- Digital Controls Allow You to Select a Temperature from 34°F to 60°F
- Elegant Midnight Black Interior
- Arctic White LED Theater-Style Lighting

High Capacity Refrigerators

MODEL	DESCRIPTION	UMRP	MSRP
MLRE024-SS01A	24" Classic Refrigerator, Stainless Solid Door	\$ 2,099	\$ 2,309

Refrigerators w/ Door Storage

MODEL	DESCRIPTION	UMRP	MSRP
MLRE124-IS11A	24" Classic Refrigerator, Panel Ready Solid Door, RH	\$ 2,279	\$ 2,519
MLRE124-IS21A	24" Classic Refrigerator, Panel Ready Solid Door, LH	\$ 2,279	\$ 2,519
MLRE124-SS11A	24" Classic Refrigerator, Stainless Solid Door, RH	\$ 2,339	\$ 2,579
MLRE124-SS21A	24" Classic Refrigerator, Stainless Solid Door, LH	\$ 2,339	\$ 2,579

See Available Door Styles on Page 84. See Available Accessories on Page 100.

CLASSIC COLLECTION REFRIGERATORS



Features

- Models with BrightShield™ Antimicrobial Lighting Create a More Hygienic Environment for Foods and Beverages
- 5.3 Cu. Ft. Capacity Stores Up to 7 Wine Bottles or 162 Cans (12 oz)
- 3-in-1 Convertible Shelf Features Removable Glass Pane with Wine Rack Option to Store Beverages, Food, or Wine
- Half-Width Shelf Allows for Tall Item Storage
- Cantilevered Shelving System Can Hold Up to 35 Lbs and Features 11 Adjustable Heights
- MaxStore Bin Stores Loose Items
- Dynamic Cooling Technology Delivers Temperature Stability
- Argon-Filled, UV-Resistant Tinted Dual Pane Glass Door Protects Contents
- Digital Controls Allow You to Select a Temperature from 34°F to 70°F
- Door Ajar and High/Low Temperature Alerts
- Adjustable LED Theater-Style Lighting in Arctic White or Sapphire Blue (Non-BrightShield Models)
- Elegant Midnight Black Interior
- Reversible Door Allows for Right or Left Swing

Refrigerators

MODEL	DESCRIPTION	UMRP	MSRP
MLRE215-IG01A	15" Classic Refrigerator, Panel Ready Glass Door	\$ 1,929	\$ 2,119
MLRE215-IS01A	15" Classic Refrigerator, Panel Ready Solid Door	\$ 1,869	\$ 2,049
MLRE215-SG01A	15" Classic Refrigerator, Stainless Glass Door	\$ 1,949	\$ 2,149
MLRE215-SS01A	15" Classic Refrigerator, Stainless Solid Door	\$ 1,889	\$ 2,079
MLRE224-BG81A	24" Classic Refrigerator, Black Glass Door, BrightShield	\$ 2,799	\$ 3,089
MLRE224-IG81A	24" Classic Refrigerator, Panel Ready Glass Door, BrightShield	\$ 2,749	\$ 3,029
MLRE224-IS81A	24" Classic Refrigerator, Panel Ready Solid Door, BrightShield	\$ 2,669	\$ 2,949
MLRE224-SG81A	24" Classic Refrigerator, Stainless Glass Door, BrightShield	\$ 2,799	\$ 3,089
MLRE224-SS81A	24" Classic Refrigerator, Stainless Solid Door, BrightShield	\$ 2,669	\$ 2,949
MLRE224-BG01A	24" Classic Refrigerator, Black Glass Door	\$ 2,589	\$ 2,849
MLRE224-IG01A	24" Classic Refrigerator, Panel Ready Glass Door	\$ 2,539	\$ 2,789
MLRE224-IS01A	24" Classic Refrigerator, Panel Ready Solid Door	\$ 2,459	\$ 2,709
MLRE224-SG01A	24" Classic Refrigerator, Stainless Glass Door	\$ 2,589	\$ 2,849
MLRE224-SS01A	24" Classic Refrigerator, Stainless Solid Door	\$ 2,459	\$ 2,709
MLDR224-IS61A	24" Classic Refrigerator Drawers, Panel Ready Solid Drawers	\$ 3,479	\$ 3,829
MLDR224-SS61A	24" Classic Refrigerator Drawers, Stainless Solid Drawers	\$ 3,399	\$ 3,729

See Available Door Styles on Page 84. See Available Accessories on Page 100.

STOCK ITEMS ARE LISTED IN RED

CLASSIC COLLECTION HIGH CAPACITY BEVERAGE CENTERS



Features

- 5.7 Cu. Ft. Capacity
- Three Adjustable and Removable Flat Glass Shelves
- Bottom Wine Storage Accommodates Larger Bottles, Including Magnums
- Dynamic Cooling Technology Delivers Temperature Stability
- Argon-Filled, UV-Resistant Tinted Dual Pane Glass Door Protects Contents
- Multifunction Controls Allow You to Select a Precise Cabinet Temperature from 34°F to 60°F
- Elegant Midnight Black Interior
- Arctic White LED Theater-Style Lighting
- Reversible Door Allows for Right or Left Swing



Single Zone Beverage Centers

MODEL	DESCRIPTION	MAP	MSRP
MLBV024-SG01B	24" Classic Beverage Center, Stainless Glass Door	\$ 1,729	\$ 1,919

MODEL	DESCRIPTION	UMRP	MSRP
MLBV024-SS01A	24" Classic Beverage Center, Stainless Solid Door	\$ 1,619	\$ 1,789

See Available Door Styles on Page 84. See Available Accessories on Page 100.

CLASSIC COLLECTION BEVERAGE CENTERS



Features

- 5.5 Cu. Ft. Capacity Stores Up to 190 Cans (12 oz) and 6 Wine Bottles
- 2 Cantilevered Steel Shelves
- 1 Removable Wine Cradle
- Cantilevered Shelving System Can Hold Up to 35 Lbs and Features 11 Adjustable Heights
- Dynamic Cooling Technology Delivers Temperature Stability
- Argon-Filled, UV-Resistant Tinted Dual Pane Glass Door Protects Contents
- Digital Controls Allow You to Select a Temperature from 34°F to 60°F
- Elegant Midnight Black Interior
- Arctic White LED Theater-Style Lighting
- Reversible Door Allows for Right or Left Swing

Single Zone Beverage Centers

MODEL	DESCRIPTION	MAP	MSRP
MLBV124-SG01A	24" Classic Beverage Center, Stainless Glass Door	\$ 1,929	\$ 2,119

See Available Door Styles on Page 84. See Available Accessories on Page 100.

STOCK ITEMS ARE LISTED IN RED

CLASSIC COLLECTION BEVERAGE CENTERS W/ 3-IN-1 SHELVES



Features

- 5.5 Cu. Ft. Capacity Stores Up to 162 Cans (12 oz) or 18 Wine Bottles
- (2) 3-in-1 Glide-Out Convertible Shelves Feature Removable Glass Pane with Wine Rack Option to Store Beverages, Food, or Wine
- Cantilevered Shelving System Can Hold Up to 35 Lbs and Features 11 Adjustable Heights
- Dynamic Cooling Technology Delivers Temperature Stability
- Vibration Neutralization System Protects Wine from Agitation
- Argon-Filled, UV-Resistant Tinted Dual Pane Glass Door Protects Contents
- Digital Controls Allow You to Select a Temperature from 34°F to 60°F
- Elegant Midnight Black Interior
- Arctic White LED Theater-Style Lighting
- Reversible Door Allows for Right or Left Swing

Single Zone Beverage Centers

MODEL	DESCRIPTION	UMRP	MSRP
MLBV215-IG01A	15" Classic Beverage Center, Panel Ready Glass Door	\$ 2,149	\$ 2,379
MLBV215-IS01A	15" Classic Beverage Center, Panel Ready Solid Door	\$ 2,119	\$ 2,329
MLBV215-SG01A	15" Classic Beverage Center, Stainless Glass Door	\$ 2,199	\$ 2,429
MLBV215-SS01A	15" Classic Beverage Center, Stainless Solid Door	\$ 2,149	\$ 2,379
MLBV224-IG01A	24" Classic Beverage Center, Panel Ready Glass Door	\$ 2,279	\$ 2,519
MLBV224-IS01A	24" Classic Beverage Center, Panel Ready Solid Door	\$ 2,129	\$ 2,339
MLBV224-SG01A	24" Classic Beverage Center, Stainless Glass Door	\$ 2,319	\$ 2,559
MLBV224-SS01A	24" Classic Beverage Center, Stainless Solid Door	\$ 2,179	\$ 2,409

See Available Door Styles on Page 84. See Available Accessories on Page 100.

CLASSIC COLLECTION DUAL ZONE BEVERAGE CENTERS



Features

- 5.0 Total Cu. Ft. - 2.69 Cu. Ft. Upper Zone and 2.3 Cu. Ft. Lower Zone
- Upper Zone Features a 3-in-1 Split Convertible Shelf That Converts to a 3- or 6-Bottle Wine Rack
- Upper Zone Can Hold Up to 112 Cans (12 oz), 64 Bottles, or an Additional 6 Wine Bottles
- Lower Zone Stores Up to 16 Wine Bottles
- Cantilevered Shelving System Can Hold Up to 35 Lbs
- Vibration Neutralization System Protects Wine from Agitation
- Dynamic Cooling Technology Delivers Temperature Stability
- Argon-Filled, UV-Resistant Tinted Dual Pane Glass Door Protects Contents
- Digital Controls Allow You to Select a Temperature for Each Zone
- Upper Zone Temperature Range: 33°F to 45°F; Lower Zone Temperature Range: 38°F to 65°F
- Elegant Midnight Black Interior
- Arctic White LED Theater-Style Lighting
- Reversible Door Allows for Right or Left Swing
- Black Shelf Front Panels

Dual Zone Beverage Centers

MODEL	DESCRIPTION	UMRP	MSRP
MLBD224-IG01A	24" Classic Dual Zone Beverage Center, Panel Ready Glass Door	\$ 3,449	\$ 3,799
MLBD224-IS01A	24" Classic Dual Zone Beverage Center, Panel Ready Solid Door	\$ 3,319	\$ 3,669
MLBD224-SG01A	24" Classic Dual Zone Beverage Center, Stainless Glass Door	\$ 3,509	\$ 3,859
MLBD224-SS01A	24" Classic Dual Zone Beverage Center, Stainless Solid Door	\$ 3,399	\$ 3,729

See Available Door Styles on Page 84. See Available Accessories on Page 100.

STOCK ITEMS ARE LISTED IN RED

CLASSIC COLLECTION WINE REFRIGERATORS



Features

- 5.7 Cu. Ft. Capacity Stores Up to 38 Bottles of Wine
- Four 8-Bottle Wine Racks
- Accommodates a Variety of Bottle Sizes
- Dynamic Cooling Technology Delivers Temperature Stability
- Argon-Filled, UV-Resistant Tinted Dual Pane Glass Door Protects Contents
- Digital Controls Allow You to Select a Temperature from 34°F to 60°F
- Elegant Midnight Black Interior
- Arctic White LED Theater-Style Lighting
- Reversible Door Allows for Right or Left Swing
- Stainless Steel Shelf Front Panels

Single Zone Wine Refrigerators

MODEL	DESCRIPTION	MAP	MSRP
MLWC024-SG01A	24" Classic Wine Refrigerator, Stainless Glass Door	\$ 1,959	\$ 2,159

See Available Door Styles on Page 84. See Available Accessories on Page 100.

CLASSIC COLLECTION WINE REFRIGERATORS



Features

- 24": 5.3 Cu. Ft. Capacity Stores Up to 54 Wine Bottles
- 15": 2.7 Cu. Ft. Capacity Stores Up to 23 Bottles of Wine
- Six 8-Bottle Glide-Out Wine Racks and One 6-Bottle Fixed Wine Cradle or Five 4-Bottle Glide-Out Wine Trays and One 3-Bottle Wine Cradle
- Accommodates a Variety of Bottle Sizes
- Vibration Neutralization System Protects Wine from Agitation
- Dynamic Cooling Technology Delivers Temperature Stability
- Argon-Filled, UV-Resistant Tinted Dual Pane Glass Door Protects Contents
- Digital Controls Allow You to Select a Temperature from 34°F to 60°F
- Elegant Midnight Black Interior
- Arctic White LED Theater-Style Lighting
- Stainable Maple Wood Shelf Front Panels
- Reversible Door Allows for Right or Left Swing

Single Zone Wine Refrigerators

MODEL	DESCRIPTION	MAP	MSRP
MLWC115-SG01A	15" Classic Wine Refrigerator, Stainless Glass Door	\$ 2,009	\$ 2,209
MODEL	DESCRIPTION	UMRP	MSRP
MLWC124-SG01A	24" Classic Wine Refrigerator, Stainless Glass Door	\$ 2,229	\$ 2,459

See Available Door Styles on Page 84. See Available Accessories on Page 100.

STOCK ITEMS ARE LISTED IN RED

CLASSIC COLLECTION HIGH EFFICIENCY WINE REFRIGERATORS



Features

- 2.7 Cu. Ft. Capacity Stores Up to 24 Bottles of Wine
- Six 4-Bottle Wine Racks
- Accommodates a Variety of Bottle Sizes
- Dynamic Cooling Technology Delivers Temperature Stability
- Vibration Neutralization System Protects Wine from Agitation
- Argon-Filled, UV-Resistant Tinted Dual Pane Glass Door Protects Contents
- Digital Controls Allow You to Select a Temperature from 34°F to 60°F
- Elegant Midnight Black Interior
- Arctic White LED Theater-Style Lighting
- Stainable Maple Shelf Fronts
- Reversible Door Allows for Right or Left Swing

Single Zone Wine Refrigerators

MODEL	DESCRIPTION	UMRP	MSRP
MLWC215-IG01A	15" Classic Wine Refrigerator, Panel Ready Glass Door	\$ 2,289	\$ 2,529
MLWC215-IS01A	15" Classic Wine Refrigerator, Panel Ready Solid Door	\$ 2,219	\$ 2,449
MLWC215-SG01A	15" Classic Wine Refrigerator, Stainless Glass Door	\$ 2,319	\$ 2,559
MLWC215-SS01A	15" Classic Wine Refrigerator, Stainless Solid Door	\$ 2,279	\$ 2,519

See Available Door Styles on Page 84. See Available Accessories on Page 100.

CLASSIC COLLECTION GALLERY DISPLAY WINE REFRIGERATORS



Features

- 5.3 Cu. Ft. Capacity Stores Up to 27 Wine Bottles
- Two 7-Bottle Gallery Display Racks, One 8-Bottle Wine Tray, and One 5-Bottle Gallery Display Rack
- Accommodates a Variety of Bottle Sizes
- Vibration Neutralization System Protects Wine from Agitation
- Dynamic Cooling Technology Delivers Temperature Stability
- Argon-Filled, UV-Resistant Tinted Dual Pane Glass Door Protects Contents
- Digital Controls Allow You to Select a Temperature from 34°F to 60°F
- Elegant Midnight Black Interior
- Arctic White LED Theater-Style Lighting
- Stainable Maple Shelf Fronts
- Reversible Door Allows for Right or Left Swing

Single Zone Wine Refrigerators

MODEL	DESCRIPTION	UMRP	MSRP
MLWC224-SG01A	24" Classic Gallery Wine Refrigerator, Stainless Glass Door	\$ 2,549	\$ 2,799

See Available Door Styles on Page 84. See Available Accessories on Page 100.

STOCK ITEMS ARE LISTED IN RED

CLASSIC COLLECTION HIGH EFFICIENCY W/ DISPLAY RACK WINE REFRIGERATORS



Features

- 5.3 Cu. Ft. Capacity Stores Up to 45 Wine Bottles
- Includes Five 8-Bottle Wire Wine Racks and One 5-Bottle Gallery Wine Rack
- Accommodates a Variety of Bottle Sizes
- Vibration Neutralization System Protects Wine from Agitation
- Dynamic Cooling Technology Delivers Temperature Stability
- Argon-Filled, UV-Resistant Tinted Dual Pane Glass Door Protects Contents
- Digital Controls Allow You to Select a Temperature from 34°F to 60°F
- Elegant Midnight Black Interior
- Arctic White LED Theater-Style Lighting
- Stainable Maple Shelf Fronts
- Reversible Door Allows for Right or Left Swing

Single Zone Wine Refrigerators

MODEL	DESCRIPTION	UMRP	MSRP
MLWC324-IG01A	24" Classic Wine Refrigerator, Panel Ready Glass Door	\$ 2,599	\$ 2,869
MLWC324-IS01A	24" Classic Wine Refrigerator, Panel Ready Solid Door	\$ 2,579	\$ 2,839
MLWC324-SG01A	24" Classic Wine Refrigerator, Stainless Glass Door	\$ 2,669	\$ 2,949
MLWC324-SS01A	24" Classic Wine Refrigerator, Stainless Solid Door	\$ 2,659	\$ 2,939

See Available Door Styles on Page 84. See Available Accessories on Page 100.

CLASSIC COLLECTION DUAL ZONE WINE REFRIGERATORS



Features

- 4.9 Cu. Ft. Capacity Stores Up to 40 Bottles of Wine
- Upper Zone Includes Three 8-Bottle Wine Racks
- Lower Zone Includes One 8-Bottle Wine Rack and Two 4-Bottle Half-Depth Wine Racks
- Accommodates a Variety of Bottle Sizes
- Vibration Neutralization System Protects Wine from Agitation
- Dynamic Cooling Technology Delivers Temperature Stability
- Argon-Filled, UV-Resistant Tinted Dual Pane Glass Door Protects Contents
- Digital Controls Allow You to Select a Temperature for Each Zone
Upper Zone: 38°F to 65°F
Lower Zone: 38°F to 65°F
(The Upper Temperature Must Be Equal to or Greater Than the Lower Temperature, Maximum 20° Higher)
- Elegant Midnight Black Interior
- Arctic White LED Theater-Style Lighting
- Stainable Maple Shelf Fronts
- Reversible Door Allows for Right or Left Swing

Dual Zone Wine Refrigerators

MODEL	DESCRIPTION	UMRP	MSRP
MLWD224-IG01A	24" Classic Dual Zone Wine Refrigerator, Panel Ready Glass Door	\$ 3,449	\$ 3,799
MLWD224-IS01A	24" Classic Dual Zone Wine Refrigerator, Panel Ready Solid Door	\$ 3,319	\$ 3,669
MLWD224-SG01A	24" Classic Dual Zone Wine Refrigerator, Stainless Glass Door	\$ 3,509	\$ 3,859
MLWD224-SS01A	24" Classic Dual Zone Wine Refrigerator, Stainless Solid Door	\$ 3,399	\$ 3,729

See Available Door Styles on Page 84. See Available Accessories on Page 100.

STOCK ITEMS ARE LISTED IN RED

CLASSIC COLLECTION REFRIGERATOR/FREEZER



Features

- 4.9 Cu. Ft. Capacity, Storing Up to 72 Cans (12 oz) and 1 Cu. Ft. Freezer Space
- Optional Crescent Ice Maker Produces Up to 7 Lbs of Ice Daily and Stores Up to 13 Lbs
- Includes 2 Half-Width Cantilevered Shelves, 1 Full-Width Fixed Shelf, and MaxStore Bin for Loose Items
- Dynamic Cooling Technology Provides Temperature Stability
- Digital Controls Allow Temperature Selection From 34°F to 42°F
- Arctic White Interior With Arctic White LED Theater-Style Lighting
- Reversible Door Allows for Right or Left Swing



Refrigerator/Freezer

MODEL	DESCRIPTION	UMRP	MSRP
MLRF224-IS01A	24" Classic Refrigerator/Freezer, Panel Ready Solid Door	\$ 2,599	\$ 2,869
MLRF224-SS01A	24" Classic Refrigerator/Freezer, Stainless Solid Door	\$ 2,729	\$ 3,009

Refrigerator/Freezer with Ice

MODEL	DESCRIPTION	UMRP	MSRP
MLRI224-IS01A	24" Classic Refrigerator/Freezer, w/ Ice, Panel Ready Solid Door	\$ 2,969	\$ 3,259
MLRI224-SS01A	24" Classic Refrigerator/Freezer, w/ Ice, Stainless Solid Door	\$ 3,099	\$ 3,419

See Available Door Styles on Page 84. See Available Accessories on Page 100.

CLASSIC COLLECTION FREEZER



Features

- 4.7 Cu. Ft. Capacity
- 2 Chrome Wire Freezer Bins and 1 Removable Cantilevered Stainless Steel Shelf
- Dynamic Cooling Technology Provides Temperature Stability
- Digital Controls Allow Temperature Selection From -10°F to 10°F
- Arctic White Interior With Arctic White LED Theater-Style Lighting
- Reversible Door Allows for Right or Left Swing

Freezer

MODEL	DESCRIPTION	UMRP	MSRP
MLFZ224-IS01A	24" Classic Freezer, Panel Ready Solid Door	\$ 2,869	\$ 3,159
MLFZ224-SS01A	24" Classic Freezer, Stainless Solid Door	\$ 2,989	\$ 3,279

See Available Door Styles on Page 84. See Available Accessories on Page 100.

STOCK ITEMS ARE LISTED IN RED

CLASSIC COLLECTION BEVERAGE DISPENSERS



Features

- 5.7 Cu. Ft. Capacity, Storing Up to 1 Half Barrel, 1 Quarter Barrel, 1 Slim Quarter Barrel, 2 Slim 1/6 Barrels, or 2 Cornelius Kegs (Cornelius Ball-Lock Fitting Not Included)
- Beer & Beverage Dispensers Work With CO2 for Carbonated Beverages Like Beer, Cider, Seltzer, and Soda; Wine & Beverage Dispensers Use Nitrogen for Wine and Non-Carbonated Drafts
- Lo-Boy Coupler for Easier Storage, Tapping, and Swapping of Tall U.S. Type D Half Barrels
- Includes 2 Stow-On-Board Stainless Steel Shelves for Bottles and Cans, Secure Gas Tank Storage, and Drain Basin
- Dynamic Cooling Technology Ensures Temperature Stability
- Integrated Drain System to Manage Spillage and Double-Insulated Tower to Reduce Foam on Pour
- Digital Controls for Temperature Selection From 34°F to 60°F
- Arctic White LED Theater-Style Lighting
- Reversible Door for Right or Left Swing

Available Tap Styles



Beverage Dispensers

MODEL	DESCRIPTION	UMRP	MSRP
MLKR224-ISA1A	24" Classic Dispenser, Single Beer & Beverage Tap, Panel Ready Solid Door	\$ 2,959	\$ 3,255
MLKR224-ISB1A	24" Classic Dispenser, Twin Beer & Beverage Tap, Panel Ready Solid Door	\$ 3,229	\$ 3,552
MLKR224-ISC1A	24" Classic Dispenser, Single Wine & Beverage Tap, Panel Ready Solid Door	\$ 3,329	\$ 3,662
MLKR224-ISD1A	24" Classic Dispenser, Twin Wine & Beverage Tap, Panel Ready Solid Door	\$ 3,959	\$ 4,355
MLKR224-SSA1A	24" Classic Dispenser, Single Beer & Beverage Tap, Stainless Solid Door	\$ 3,089	\$ 3,398
MLKR224-SSB1A	24" Classic Dispenser, Twin Beer & Beverage Tap, Stainless Solid Door	\$ 3,359	\$ 3,695
MLKR224-SSC1A	24" Classic Dispenser, Single Wine & Beverage Tap, Stainless Solid Door	\$ 3,459	\$ 3,805
MLKR224-SSD1A	24" Classic Dispenser, Twin Wine & Beverage Tap, Stainless Solid Door	\$ 4,099	\$ 4,509

Dispenser Accessories

MODEL	DESCRIPTION	UMRP	MSRP
42242373-ACCY	Tap Cleaning Kit	\$ 159	\$ 179
S41014172-ACCY	External CO2 Metal Mounting Bracket Kit	\$ 59	\$ 69
S42418192-ACCY	Beer Drain Sump	\$ 59	\$ 69
S42418645-ACCY	Beer Single Tap Kit w/ CO2 Tank	\$ 949	\$ 1,049
S42418646-ACCY	Beer Twin Tap Kit w/ CO2 Tank	\$ 1,319	\$ 1,459
S42418647-ACCY	Wine Single Tap Kit w/ Nitro Tank	\$ 1,249	\$ 1,379
S42418648-ACCY	Wine Twin Tap Kit w/ Nitro Tank	\$ 1,879	\$ 2,069

See Available Door Styles on Page 84. See Available Accessories on Page 100.



STOCK ITEMS ARE LISTED IN RED

MARVEL REFRIGERATION ACCESSORIES

Dispenser Accessories

MODEL	DESCRIPTION	UMRP	MSRP
42242373-ACCY	Tap Cleaning Kit	\$ 159	\$ 179
S41014172-ACCY	External CO2 Metal Mounting Bracket Kit	\$ 59	\$ 69
S42418192-ACCY	Beer Drain Sump	\$ 59	\$ 69
S42418645-ACCY	Beer Single Tap Kit w/ CO2 Tank	\$ 949	\$ 1,049
S42418646-ACCY	Beer Twin Tap Kit w/ CO2 Tank	\$ 1,319	\$ 1,459
S42418647-ACCY	Wine Single Tap Kit w/ Nitro Tank	\$ 1,249	\$ 1,379
S42418648-ACCY	Wine Twin Tap Kit w/ Nitro Tank	\$ 1,879	\$ 2,069

Installation Accessories

MODEL	DESCRIPTION	UMRP	MSRP
42242832-ACCY	18" Black Filler Kit	\$ 79	\$ 89
42242833-ACCY	18" Stainless Filler Kit	\$ 79	\$ 89
42249443-ACCY	Stacking Kit (24" Models)	\$ 129	\$ 149

Shelving Accessories

MODEL	DESCRIPTION	UMRP	MSRP
42248725-ACCY	24" Half-Width Flat Shelf, Natural Maple Front	\$ 29	\$ 39
42248729-ACCY	24" Full-Width Flat Shelf, Natural Maple Front	\$ 29	\$ 39



Outdoor Collection

Bring the entertainment outdoors with the Marvel Outdoor Collection. Our range of beverage dispensers, refrigerators and ice machines are crafted with stainless steel that has been salt spray tested for corrosion resistance, making them the perfect match for your outdoor bar, kitchen or patio. Experience the ideal blend of style, durability, and functionality, and elevate your outdoor entertaining experience.

- Variety of Products Designed for Outdoor Installations
- Available in 24" & 15" Size Options
- Field Reversible Doors (Excluding Drawers & Models With Door Storage)
- Arctic White LED Interior Lighting
- Pivot Hinges
- Half-Width Shelves on Select Beverage Centers & Refrigerators to Accommodate Tall Items
- Stainless Steel Accents
- Adjustable Cantilevered Shelving
- Robust, Professional Style Door Handle
- Standard Door Lock (Excluding Ice Machines)
- 1-Year Parts & Labor / 5-Year Sealed System Parts Warranty
- Ice Machines on Page 75

Available Door Styles



Stainless Steel Drawers



Stainless Steel Solid

* Not all door styles available for every application.

OUTDOOR COLLECTION REFRIGERATORS



Features

- 15" Model (MORE215): 2.7 Cu. Ft. Capacity, Stores Up to 70 Cans (12 oz)
- 24" Model (MORE124): 5.3 Cu. Ft. Capacity, Stores Up to 154 Cans (12 oz)
- 24" Model With Door Storage (MORE224): 5.1 Cu. Ft. Capacity, Stores Up to 146 Cans (12 oz); Features Half-Width Shelf for Tall Items, Cantilevered Stainless Steel Slide-Out Shelf, and MaxStore Bin for Loose Items
- 24" Drawer Model (MODR224): 5.0 Cu. Ft. Capacity, Stores Up to 108 Cans (12 oz); Includes Adjustable Dividers in Both Drawers to Prevent Sliding
- 24" Model With Freezer (MORF224): 3.9 Cu. Ft. Capacity, Holds Up to 72 Cans (12 oz); 1 Cu. Ft. Freezer Holds Up to 12 Pints of Ice Cream or Crescent Ice Maker Produces Up to 7 Lbs of Ice Per Day and Stores Up to 13 Lbs; Includes 2 Half-Width Cantilevered Shelves, 1 Full-Width Fixed Shelf, and MaxStore Bin
- Designed for Outdoor Use
- Dynamic Cooling Technology Delivers Temperature Stability
- Digital Controls Allow Temperature Selection From 34°F to 60°F (24" With Freezer: 34°F to 42°F)
- Adjustable LED Theater-Style Lighting in Arctic White
- Arctic White Interior
- Reversible Door on Select Models Allows for Right or Left Swing
- Door Lock Provides Added Security

Refrigerators

MODEL	DESCRIPTION	UMRP	MSRP
MORE215-SS31A	15" Outdoor Refrigerator, Stainless Solid Door, Locking	\$ 2,469	\$ 2,729
MORE124-SS31A	24" Outdoor Refrigerator, Stainless Solid Door, Locking	\$ 2,839	\$ 3,139

Refrigerators w/ Door Storage

MODEL	DESCRIPTION	UMRP	MSRP
MORE224-SS41A	24" Outdoor Refrigerator, Stainless Solid Door, RH, Locking	\$ 3,489	\$ 3,839
MORE224-SS51A	24" Outdoor Refrigerator, Stainless Solid Door, LH, Locking	\$ 3,489	\$ 3,839
MODR224-SS71A	24" Outdoor Refrigerator Drawers, Stainless Solid Drawers, Locking	\$ 4,659	\$ 5,129

Refrigerator/Freezers

MODEL	DESCRIPTION	UMRP	MSRP
MORF224-SS31A	24" Outdoor Refrigerator/Freezer, Stainless Solid Door, Locking	\$ 3,349	\$ 3,689
MORI224-SS31A	24" Outdoor Refrigerator/Freezer, w/ Ice, Stainless Solid Door, Locking	\$ 3,719	\$ 4,139

See Available Door Styles on Page 101. See Available Accessories on Page 110.

STOCK ITEMS ARE LISTED IN RED

OUTDOOR COLLECTION FREEZER



Features

- 4.7 Cu Ft Capacity
- 2 Chrome Wire Freezer Bins
- 1 Removable Cantilevered Stainless Steel Shelf
- Designed for Outdoor Use
- Dynamic Cooling Technology Delivers Temperature Stability
- Digital Controls Allow You to Select a Temperature From -10°F to 10°F
- Arctic White Interior
- Arctic White LED Theater-Style Lighting
- Reversible Door Allows for Right or Left Swing
- Door Lock Provides Added Security

Freezer

MODEL	DESCRIPTION	UMRP	MSRP
MOFZ224-SS31A	24" Outdoor Freezer, Stainless Solid Door, Locking	\$ 3,649	\$ 4,029

See Available Door Styles on Page 101. See Available Accessories on Page 110.

OUTDOOR COLLECTION BEVERAGE DISPENSERS



Features

- 5.7 Cu. Ft. Capacity, Stores Up to 1 Half Barrel, 1 Quarter Barrel, 1 Slim Quarter Barrel, 2 Slim 1/6 Barrels, or 2 Cornelius Kegs (Cornelius Ball-Lock Fitting Not Included)
- Beer & Beverage Dispensers Designed to Work With CO2 for Beer, Cider, Seltzer, Soda, and More
- Wine & Beverage Dispensers Use Nitrogen to Dispense Wine or Other Non-Carbonated Draft Beverages
- Lo-Boy Coupler Makes It Easier to Store, Tap, and Swap Out Tall U.S. Type D Half Barrels
- Double-Insulated Tower Reduces Foam on Pour
- Integrated Drain System Keeps Spillage Under Control
- Includes 2 Stow-On-Board Stainless Steel Shelves to Store Bottles and Cans
- Designed for Outdoor Use
- Dynamic Cooling Technology Delivers Temperature Stability
- Digital Controls Allow Temperature Selection From 34°F to 60°F
- Arctic White Interior With Arctic White LED Theater-Style Lighting
- Reversible Door Allows for Right or Left Swing
- Door Lock Provides Added Security

Available Tap Styles



Beverage Dispensers

MODEL	DESCRIPTION	UMRP	MSRP
MOKR124-SSA1A	24" Outdoor Dispenser, Single Beer & Beverage Tap, Stainless Solid Door, Locking	\$ 3,409	\$ 3,750
MOKR124-SSB1A	24" Outdoor Dispenser, Twin Beer & Beverage Tap, Stainless Solid Door, Locking	\$ 3,679	\$ 4,047
MOKR124-SSC1A	24" Outdoor Dispenser, Single Wine & Beverage Tap, Stainless Solid Door, Locking	\$ 3,799	\$ 4,179
MOKR124-SSD1A	24" Outdoor Dispenser, Twin Beer & Beverage Tap, Stainless Solid Door, Locking	\$ 4,419	\$ 4,861

Mobile Beverage Dispensers

MODEL	DESCRIPTION	UMRP	MSRP
MOKR224-SSA1A	24" Mobile Outdoor Dispenser, Single Beer & Beverage Tap, Stainless Solid Door, Locking	\$ 3,839	\$ 4,223
MOKR224-SSB1A	24" Mobile Outdoor Dispenser, Twin Beer & Beverage Tap, Stainless Solid Door, Locking	\$ 4,109	\$ 4,520
MOKR224-SSC1A	24" Mobile Outdoor Dispenser, Single Wine & Beverage Tap, Stainless Solid Door, Locking	\$ 3,899	\$ 4,289
MOKR224-SSD1A	24" Mobile Outdoor Dispenser, Twin Beer & Beverage Tap, Stainless Solid Door, Locking	\$ 4,619	\$ 5,081

Dispenser Accessories

MODEL	DESCRIPTION	UMRP	MSRP
42242373-ACCY	Tap Cleaning Kit	\$ 159	\$ 179
S41014172-ACCY	External CO2 Metal Mounting Bracket Kit	\$ 59	\$ 69
S42418192-ACCY	Beer Drain Sump	\$ 59	\$ 69
S42418645-ACCY	Beer Single Tap Kit w/ CO2 Tank	\$ 949	\$ 1,049
S42418646-ACCY	Beer Twin Tap Kit w/ CO2 Tank	\$ 1,319	\$ 1,459
S42418647-ACCY	Wine Single Tap Kit w/ Nitro Tank	\$ 1,249	\$ 1,379
S42418648-ACCY	Wine Twin Tap Kit w/ Nitro Tank	\$ 1,879	\$ 2,069

See Available Door Styles on Page 101. See Available Accessories on Page 110.



Low Profile (ADA) Collection

Our Low Profile Collection of refrigerators, beverage centers and ice makers are ideal for ADA-height installations, universal design applications, and areas with limited space. Our products are designed to meet the needs of various settings, including world-class sports and entertainment venues, hotels, hospitals, medical facilities, and other premium commercial installations throughout America.

- ADA-Height Design for Smaller Areas & Universal Design Applications
- Available in 24", 15" & 14" Size Options
- Field Reversible Doors (Excluding Models With Door Storage)
- Arctic White LED Interior Lighting
- Pivot Hinges
- Half-Width Shelves on Select Beverage Centers & Refrigerators to Accommodate Tall Items
- Black Shelf Accents
- Adjustable Cantilevered Shelving With 3-in-1 Convertible Shelving to Store Food, Beverages, & Wine
- Tube Style Door Handle
- Standard Door Lock (Excluding Ice Machines)
- 1 Year Parts & Labor / 5 Year Sealed System Parts Warranty
- Ice Machines on Page 76

Available Door Styles



Panel Ready Solid



Stainless Steel Glass



Stainless Steel Solid

* Not all door styles available for every application.

LOW PROFILE COLLECTION REFRIGERATORS



Features

- 24" w/o Door Storage: 4.9 Cu. Ft. Capacity Stores Up to 95 Cans (12-oz) and 18 Wine Bottles
- 24" w/ Door Storage: 4.6 Cu. Ft. Capacity Stores Up to 118 Cans (12-oz)
- Half-Width Shelf Allows for Tall Item Storage
- MaxStore Bin Stores Loose Items
- Dynamic Cooling Technology Delivers Temperature Stability
- Digital Controls Allow You to Select a Temperature From 34°F to 60°F
- Argon Filled, UV-Resistant Tinted Dual Pane Glass Door Protects Contents
- Low Profile, ADA-Compliant Height Allows for Universal Installation Applications
- Arctic White or Midnight Black Interior
- Arctic White LED Theater-Style Lighting
- Door Lock Provides Added Security
- Reversible Door Allows for Right or Left Swing (w/o Door Storage only)

Refrigerators

MODEL	DESCRIPTION	UMRP	MSRP
MARE124-SG31A	24" Low Profile Refrigerator, Stainless Glass Door, Locking	\$ 2,279	\$ 2,519
MARE124-SS31A	24" Low Profile Refrigerator, Stainless Solid Door, Locking	\$ 2,199	\$ 2,429

Refrigerators with Door Storage

MODEL	DESCRIPTION	UMRP	MSRP
MARE224-IS41A	24" Low Profile Refrigerator, Panel Ready Solid Door, RH, Locking	\$ 2,439	\$ 2,679
MARE224-IS51A	24" Low Profile Refrigerator, Panel Ready Solid Door, LH, Locking	\$ 2,439	\$ 2,679
MARE224-SS41A	24" Low Profile Refrigerator, Stainless Solid Door, RH, Locking	\$ 2,549	\$ 2,799
MARE224-SS51A	24" Low Profile Refrigerator, Stainless Solid Door, LH, Locking	\$ 2,549	\$ 2,799

See Available Door Styles on Page 105. See Available Accessories on Page 110.

LOW PROFILE COLLECTION BEVERAGE CENTER



Features

- 4.9 Cu. Ft. Capacity Stores Up to 95 Cans (12-oz) and 7 Wine Bottles
- 3-in-1 Convertible Shelf Features Removable Glass Pane With Wine Rack Option to Store Beverages, Food, or Wine
- Half-Width Shelf Allows for Tall Item Storage
- MaxStore Bin Stores Loose Items
- Dynamic Cooling Technology Delivers Temperature Stability
- Argon Filled, UV-Resistant Tinted Dual Pane Glass Door Protects Contents
- Digital Controls Allow You to Select a Temperature From 34°F to 60°F
- Low Profile, ADA-Compliant Height Allows for Universal Installation Applications
- Elegant Midnight Black Interior
- Arctic White LED Theater-Style Lighting
- Reversible Door Allows for Right or Left Swing
- Door Lock Provides Added Security

Beverage Center

MODEL	DESCRIPTION	UMRP	MSRP
MABV224-SG31A	24" Low Profile Beverage Center, Stainless Glass Door, Locking	\$ 2,819	\$ 3,109

See Available Door Styles on Page 105. See Available Accessories on Page 110.



STOCK ITEMS ARE LISTED IN RED

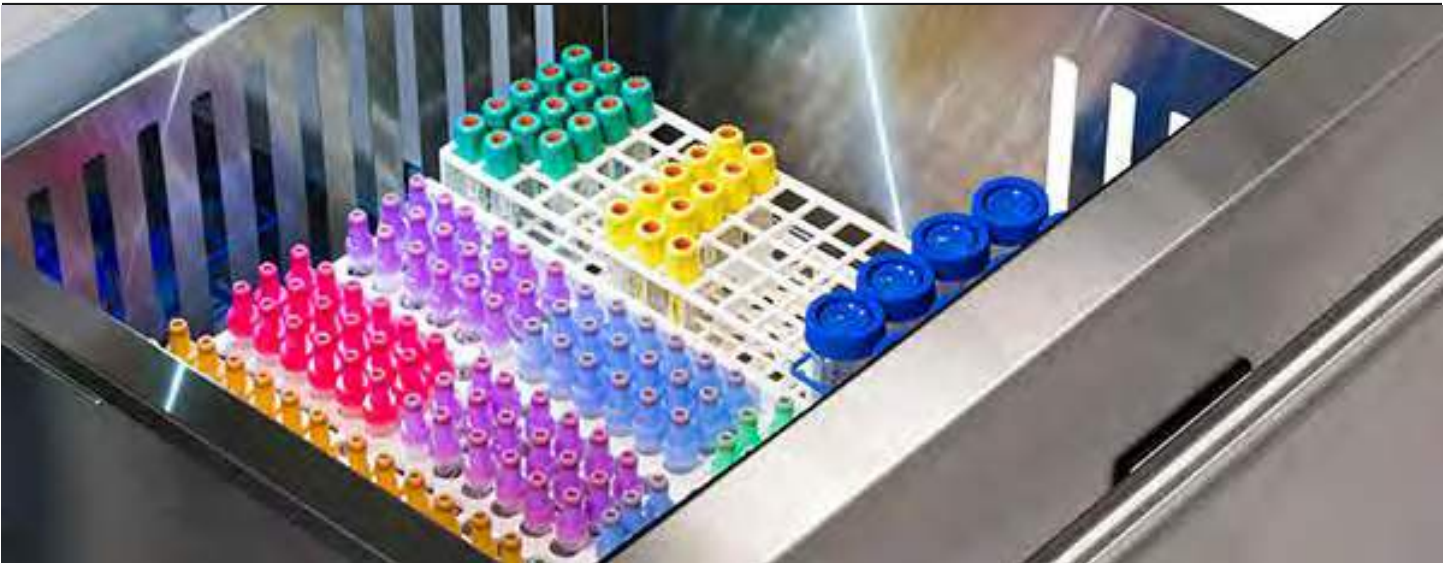

Scientific Commercial

By choosing Marvel Scientific Commercial refrigerators and freezers, you are choosing the performance and safety assured by our tough construction and strict standards. Marvel Scientific products are specifically engineered to perform to the precise demands of the health, sciences and industrial fields. We understand the complex and sophisticated refrigeration specifications required to preserve valuable biological and chemical materials.





SCIENTIFIC REFRIGERATORS

Refrigerators

MODEL	DESCRIPTION	UMRP	MSRP
MS15RAS4RW	15" Scientific Refrigerator, Probe Port, White Solid Door, RH, Locking	\$ 3,569	\$ 3,929
MS24RAG4RW	24" Scientific Refrigerator, Probe Port, White Glass Door, RH, Locking	\$ 3,959	\$ 4,359
MS24RAS4LW	24" Scientific Refrigerator, Probe Port, White Solid Door, LH, Locking	\$ 3,669	\$ 4,039
MS24RAS4RW	24" Scientific Refrigerator, Probe Port, White Solid Door, RH, Locking	\$ 3,669	\$ 4,039
MS24RAS5LS	24" Scientific Refrigerator, Probe Port, Stainless Solid Door, LH, Locking	\$ 5,159	\$ 5,679
MS24RAS5RS	24" Scientific Refrigerator, Probe Port, Stainless Solid Door, RH, Locking	\$ 5,159	\$ 5,679
MS24RASWRW	24" Scientific Refrigerator, White Solid Door, RH	\$ 3,989	\$ 4,389

ADA Height Refrigerators

MODEL	DESCRIPTION	UMRP	MSRP
SA24RAS4LW	24" Scientific Refrigerator, Probe Port, White Solid Door, LH, Locking	\$ 3,729	\$ 4,109
SA24RAS4RW	24" Scientific Refrigerator, Probe Port, White Solid Door, RH, Locking	\$ 3,729	\$ 4,109
SA24RAS5LS	24" Scientific Refrigerator, Probe Port, Stainless Solid Door, LH, Locking	\$ 4,319	\$ 4,759
SA24RAS5RS	24" Scientific Refrigerator, Probe Port, Stainless Solid Door, RH, Locking	\$ 4,319	\$ 4,759

Refrigerator/Freezers

MODEL	DESCRIPTION	UMRP	MSRP
MS24RDS4NS	24" Scientific Refrigerator/Freezer Drawers, Probe Port, Frost Free, White Solid Drawers, Locking	\$ 6,229	\$ 6,859
MS24RFS2RW	24" Scientific Refrigerator/Freezer, Probe Port, Manual Defrost, White Solid Door, RH, Locking	\$ 3,589	\$ 3,949
MS24RFS4LW	24" Scientific Refrigerator/Freezer, Probe Port, White Solid Door, LH, Locking	\$ 5,119	\$ 5,639
MS24RFS4RW	24" Scientific Refrigerator/Freezer, Probe Port, White Solid Door, RH, Locking	\$ 5,119	\$ 5,639
MS24RFSGRG	24" Scientific Refrigerator/Freezer, Manual Defrost, Olive Green Solid Door, RH	\$ 6,209	\$ 6,829

Freezers

MODEL	DESCRIPTION	UMRP	MSRP
MS24FAS4LW	24" Scientific Freezer, Probe Port, White Solid Door, LH, Locking	\$ 4,739	\$ 5,219
MS24FAS4RW	24" Scientific Freezer, Probe Port, White Solid Door, RH, Locking	\$ 4,739	\$ 5,219

See Available Accessories on Page 110.



STOCK ITEMS ARE LISTED IN RED

MARVEL REFRIGERATION ACCESSORIES

Dispenser Accessories

MODEL	DESCRIPTION	UMRP	MSRP
42242373-ACCY	Tap Cleaning Kit	\$ 159	\$ 179
S41014172-ACCY	External CO2 Metal Mounting Bracket Kit	\$ 59	\$ 69
S42418192-ACCY	Beer Drain Sump	\$ 59	\$ 69
S42418645-ACCY	Beer Single Tap Kit w/ CO2 Tank	\$ 949	\$ 1,049
S42418646-ACCY	Beer Twin Tap Kit w/ CO2 Tank	\$ 1,319	\$ 1,459
S42418647-ACCY	Wine Single Tap Kit w/ Nitro Tank	\$ 1,249	\$ 1,379
S42418648-ACCY	Wine Twin Tap Kit w/ Nitro Tank	\$ 1,879	\$ 2,069

Ice Maker Accessories

MODEL	DESCRIPTION	UMRP	MSRP
S41013789	4 oz. Ice Machine Cleaner	\$ 59	\$ 69
90-17047-ACCY	Stainless Solid Door w/ Pro-Style Handle for MRNP215-IS01A Nugget Ice Machine	\$ 229	\$ 259

Installation Accessories

MODEL	DESCRIPTION	UMRP	MSRP
42242832-ACCY	18" Black Filler Kit	\$ 79	\$ 89
42242833-ACCY	18" Stainless Filler Kit	\$ 79	\$ 89
42249443-ACCY	Stacking Kit (24" Models)	\$ 129	\$ 149

Shelving Accessories

MODEL	DESCRIPTION	UMRP	MSRP
42248725-ACCY	24" Half-Width Flat Shelf, Natural Maple Front	\$ 29	\$ 39
42248729-ACCY	24" Full-Width Flat Shelf, Natural Maple Front	\$ 29	\$ 39



U-LINE AND MARVEL CORPORATION LIMITED WARRANTY

One Year Limited Warranty - U-Line and Marvel Residential Products

For one year from the date of original purchase, this warranty covers all parts and labor to repair or replace any part of the product that proves to be defective in materials or workmanship. For products installed and used for normal residential use, material cosmetic defects are included in this warranty, with coverage limited to 60 days from the date of original purchase. All service provided by U-Line and Marvel under the above warranty must be performed by a U-Line and Marvel factory authorized servicer, unless otherwise specified by U-Line and Marvel. Service provided during normal business hours.

Two Year Limited Warranty (U-Line 5 Class and Marvel Professional Products)

For two years from the date of original purchase, this warranty covers all parts and labor to repair or replace any part of the product that proves to be defective in materials or workmanship. For products installed and used for normal residential use, material cosmetic defects are included in this warranty, with coverage limited to 60 days from the date of original purchase. All service provided by U-Line and Marvel under the above warranty must be performed by a U-Line and Marvel factory authorized servicer, unless otherwise specified by U-Line and Marvel. Service provided during normal business hours.

Available Second (U-Line Products Excluding 5 Class) & Third Year Limited Warranty (U-Line 5 Class and Marvel Professional Products)

In addition to the standard one and two-year warranties outlined above, U-Line and Marvel offers a one-year extension of the warranties from the date of purchase, free of charge. To take advantage of this extension, you must register your product with U-Line or Marvel within 60 days from the date of purchase at u-line.com or marvelrefrigeration.com and provide proof of purchase.

Five Year Sealed System Limited Warranty

For five years from the date of original purchase, U-Line and Marvel will repair or replace the following parts, labor not included, that prove to be defective in materials or workmanship: compressor, condenser, evaporator, drier, and all connecting tubing. All service provided by U-Line and Marvel under the above warranty must be performed by a U-Line and Marvel factory authorized servicer, unless otherwise specified by U-Line and Marvel. Service provided during normal business hours.

Terms

These warranties apply only to products installed in any one of the fifty states of the United States, the District of Columbia, or the ten provinces of Canada. The warranties do not cover any parts or labor to correct any defect caused by negligence, accident or improper use, maintenance, installation, service, repair, acts of God, fire, flood or other natural disasters. The product must be installed, operated, and maintained in accordance with your product's User Guide.

The remedies described above for each warranty are the only ones that U-Line and Marvel will provide, either under these warranties or under any warranty arising by operation of law. U-Line and Marvel will not be responsible for any consequential or incidental damages arising from the breach of these warranties or any other warranty, whether express, implied, or statutory. Some states do not allow the exclusion or limitation of incidental or consequential damages, so the above limitation or exclusion may not apply to you. These warranties give you specific legal rights, and you may also have other rights which vary from state to state.

Any warranty that may be implied in connection with your purchase or use of the product, including any warranty of merchantability or any warranty fit for a particular purpose is limited to the duration of these warranties, and only extends to five years in duration for the parts described in the section related to the five-year limited warranty above. Some states do not allow limitations on how long an implied warranty lasts, so the above limitations may not apply to you.

- The warranties only apply to the original purchaser and are non-transferable.
- The second, third, and five-year warranties cover products installed and used for normal residential or designated marine use only.
- The warranties apply to units operated outside only if designed for outdoor use by model and serial number.
- Marvel non-Professional products are covered by the one year and 5-year limited warranties and are not eligible for the second and third year limited warranties.
- Replacement water filters, light bulbs, and other consumable parts are not covered by these warranties.
- The start of U-Line and Marvel's obligation is limited to four years after the shipment date from U-Line and Marvel.
- In-home instruction on how to use your product is not covered by these warranties.
- Food, beverage, and medicine loss are not covered by these warranties.
- If the product is located in an area where U-Line and Marvel factory authorized service is not available, you may be responsible for a trip charge or you may be required to bring the product to a U-Line and Marvel factory authorized service location at your own cost and expense.
- Units purchased after use as floor displays, and/or certified reconditioned units, are covered by the limited one-year warranty only and no coverage is provided for cosmetic defects.
- Signal issues related to Wi-Fi connectivity are not covered by these warranties.

See complete warranty documents at u-line.com and marvelrefrigeration.com.



PINNACLE SALES GROUP TERMS AND CONDITIONS OF SALE

Orders: All orders and any subsequent change orders must be submitted in writing and delivered to Pinnacle Express, Inc. dba Pinnacle Sales Group by mail, fax or e-mail. No telephone orders will be accepted. Special Order items are Non-Cancellable.

Prices: All prices are subject to change without notice and are exclusive of any sales or use taxes, shipping, delivery, special packaging, or handling charges that may apply to each customer or to each order.

Minimum Advertised Pricing: All sales are subject to Pinnacle Express, Inc. dba Pinnacle Sales Group or Manufacturer minimum advertised prices. Failure to comply with minimum advertised prices will result in cancellation of any agreement and violators will not be entitled to purchase further products.

Minimum Sale Price: All sales are subject to Pinnacle Express, Inc. dba Pinnacle Sales Group or Manufacturer minimum sale prices. Failure to comply with minimum sale prices will result in cancellation of any agreement and violators will not be entitled to purchase further products.

Freight and Handling: Pinnacle Express, Inc. dba Pinnacle Sales Group reserves the right to ship products by its choice of carrier. All shipments are F.O.B. from place of shipment, and risk of loss shall pass to the Buyer upon delivery to the carrier at the point of shipment. Additional charges may apply for special handling and packaging.

Deliveries: Pinnacle Express, Inc. dba Pinnacle Sales Group shall not be liable for failure to deliver or for delays in delivery or performance due to: (1) causes beyond its reasonable control; (2) acts of God, acts of Buyer, acts of civil or military authority, governmental allocations or controls, fires, strikes or other labor difficulties, riots or other civil disturbances, delays in its usual source of supply, delays in transportation; (3) any other commercial impracticability. In the event of such delay, the date of delivery or performance shall be extended for a period equal to the time lost by reason of the delay.

Claims: All claims for non-conforming delivery of Products must be made within thirty (30) days of receipt of shipment.

Damage or Loss: Any claim for damage or loss in shipment should be made to the carrier immediately by the customer. Products become the responsibility of the Buyer when accepted by the carrier in good condition from Pinnacle Express, Inc. dba Pinnacle Sales Group and we are not able to process shipping damage claims.

Returns: Only Items marked in this Price List as "Stock Item" are subject to return. All other items are considered Special Order Items and are NOT RETURNABLE. No Products may be returned without a Pinnacle Express, Inc. dba Pinnacle Sales Group Return Goods Authorization (RGA) Number issued prior to the return of Product. Any product returned without an RGA will be refused and returned to the sender. RGA's are valid for thirty (30) days only. All returns are subject to inspection before being approved for credit - products must be in salable condition to be considered for return or replacement. A 20% restocking charge will apply to all returns.

Payment: Unless otherwise noted, payment terms are Net Due on Receipt. Balances owed on invoices over 30 days old are subject to a 1.5% per month charge. Payments made by a credit card are subject to a 2% processing fee. Each shipment or delivery shall be deemed to have been sold under a separate and or independent contract and payment thereof shall be made in accordance with the terms of this agreement and of the invoice rendered by Pinnacle Express, Inc. dba Pinnacle Sales Group Buyer agrees that title to the personal property described herein shall not vest in Buyer until paid in full. In the event of insolvency or the filing of bankruptcy by the Buyer, Buyer agrees to return all merchandise to Pinnacle Express, Inc. dba Pinnacle Sales Group

Warranties: Products distributed by Pinnacle Express, Inc. dba Pinnacle Sales Group are the products of reputable manufacturers sold under their respective brand or trade names. Pinnacle Express, Inc. dba Pinnacle Sales Group shall use its best efforts to obtain from each manufacturer, in accordance with the manufacturer's warranty or customary practice, the repair or replacement of products that may prove defective in material or workmanship. The foregoing shall constitute the exclusive remedy of the Buyer and the sole obligation of Pinnacle Express, Inc. dba Pinnacle Sales Group Except as to Title, THERE ARE NO WARRANTIES, EITHER WRITTEN, ORAL, IMPLIED, OR STATUTORY relating to the described products which shall extend beyond that described in this paragraph. NO WARRANTY OF MERCHANTABILITY OR OF FITNESS FOR PURPOSE SHALL APPLY.

Limitation of Liability: Pinnacle Express, Inc. dba Pinnacle Sales Group's liability on any claims for loss or damage arising out of this contract or from the performance or breach thereof or connected with the supplying of products hereunder, or its sale, resale, operation or use, whether based on warranty, contract, negligence or other grounds shall not exceed the price allowable for such products or parts thereof involved in the claim. Pinnacle Express, Inc. dba Pinnacle Sales Group shall not, under any circumstances, be liable for any labor charges unless agreed upon in advance and in writing by Pinnacle Express, Inc. dba Pinnacle Sales Group and the manufacturer of the products involved. Pinnacle Express, Inc. dba Pinnacle Sales Group shall not in any event be liable for special or consequential damages, including, but not limited to, loss of profits or revenue, loss of use of the product or any associated product, cost of capital, cost of substitute products, facilities or services, downtime costs, or claims of customers of the Buyer for such damages.

General: The possession of this Price List by anyone is not to be considered as an offer to sell any of the Products contained herein. This Price List supercedes all previous price lists or memorandums. Pinnacle Express, Inc. dba Pinnacle Sales Group's existing Trade Terms and Conditions remain in effect. The above Terms and Conditions shall be a part of all Orders accepted by Pinnacle Express, Inc. dba Pinnacle Sales Group and shall supercede any conflicting provisions of our customer's purchase orders. These terms and conditions are subject to change without notice.



NOTES

Lined area for handwritten notes.





NOTES

Lined area for notes

NOTES



PINNACLE
SALES GROUP



Pinnacle Sales Group

P.O. Box 1836 • Dundee, FL 33838
800-292-8374
www.pinnaclesalesgroup.com

UL-MV-PB-2025-01